



# Wastewater Treatment Solutions



WASTEWATER TREATMENT SYSTEMS  
SEPTIC TANKS CESSPOOLS INFILTRATION



Dachstein plant (France)



Teningen plant (Germany)

## GRAF and KLARO – two strong brands with a reputation for quality

For more than 50 years, the GRAF brand has represented high-quality plastic products. Our Carat wastewater tanks represent the state of the art. Our long-standing partner KLARO, which joined our group of companies in 2014, has

grown over the last 10 years to become the European market leader in small SBR treatment systems with airlift technology. Our small wastewater treatment systems are already being used by 240,000 satisfied customers.

When you buy a GRAF wastewater treatment system, you benefit from the experience gained from more than 300 000 satisfied wastewater customers and the quality of two established brands in local wastewater disposal.



### Commitment to Germany as our corporate site

GRAF continually invests in the development of its headquarters in Teningen, Germany. Covering an area of 155 000 square metres – equivalent to 31 football pitches – it is one of the world's most modern manufacturing facilities for plastic products. We feel a strong sense of loyalty to Germany as our corporate site. For one thing, our long history means we have deep-rooted ties with the site. And for another, here in Teningen we have access to a highly skilled and motivated workforce who enable us to uphold and develop our high quality standards.

### Quality comes first

GRAF uses state-of-the-art production facilities. This is the only way to guarantee superlative quality at attractive prices. A high standard of quality in production is an essential foundation for unique products. End-to-end quality assurance and a high level of automation guarantee maximum reliability in production. GRAF broke into new ground by using injection embossing to make the Carsten S wastewater tank. To manufacture this tank, GRAF commissioned the development and construction of the world's largest injection moulding machine.

### Plastic – clear advantages

Because of their low weight, plastic tanks can be installed without heavy equipment. This means that they can be easily transported and installed in locations that are difficult to access. Plastic tanks, have smooth inner surfaces that will not corrode.





## The manufacturing process is essential for a top-quality product

Our products have to fulfil a wide range of requirements. GRAF has expertise in all standard plastic manufacturing processes and can access the optimum process for a given product.

### Sustainability starts with production

GRAF products help to protect the environment, so it goes without saying that they are also manufactured in an environmentally friendly way. Injection-moulding a plastic part usually requires up to 2.7 kilowatt hours of electricity per kilogram of plastic. GRAF needs just 0.38 to 0.5 kilowatt hours.

The injection moulding process therefore consumes up to **85% less energy** than normal.

The heat generated during manufacturing is processed by a modern heat recovery system and is used to heat the production and logistics buildings.

### Durable products: reliable investment

Right from the product development stage, GRAF attaches great importance to durable design. Our decades of experience combined with modern production techniques guarantee that our plastic tanks last for over 50 years. GRAF offers a warranty of up to 25 years for its wastewater tanks. A 3-year warranty is offered for SBR technology, with an optional 6-year extended warranty. The efficiency of our wastewater treatment systems is regularly monitored by independent institutes. All products manufactured by GRAF are also 100% recyclable.



World's largest injection moulding machine



Blow moulding



Rotational moulding



Manufacturing certified according to ISO 9001

# Internationally proven: GRAF Wastewater Treatment Systems



15 inhabitants, Fürenalp (Switzerland)



80 inhabitants, Cayenne (French Guiana)



50 inhabitants, Šuškova (Latvia)



5 inhabitants, Arlanda (Sweden)



200 inhabitants, Tumenzagt (Mongolia)



80 inhabitants, Fares (Spain)



35 inhabitants, Le Mans (France)



90 inhabitants, Mexico City (Mexico)



32 inhabitants, British Columbia (Canada)



4 inhabitants, Perth (Australia)



60 inhabitants, Tryserum (Sweden)



90 inhabitants, Tehran (Iran)



32 inhabitants, Haneberg (Sweden)



7 inhabitants, Tiflis (Georgia)



115 inhabitants, Le Pasquier (France)



5 inhabitants, Uurainen (Finland)



32 inhabitants, Plovdiv (Bulgaria)



200 inhabitants, Rudenki Town (Ukraine)



Product finder	World of water	8
Small Biological Wastewater Treatment Systems	Klaro E Professional – Facts	12
	Klaro E Professional – Benefits	14
	Klaro E Professional – One-tank system	16
	Klaro E Professional – Multitank system	18
	Accessories	20
	Klaro E Professional for retrofitting	22
	one2clean – Facts	24
	one2clean – Benefits	26
	one2clean – One-tank system / Two-tank system	28
Large Biological Wastewater Treatment Systems	Klaro L	32
	Moving Bed	33
	Klaro XL	34
	Klaro XXL	35
	Klaro XXL Retrofitting	36
Mechanical Wastewater Treatment Systems	Anaerobix	42
	Carat S Septic tank	44
	Carat S / Carat XL / Carat XXL Cesspool	45
	Platin Cesspool	46
	Herkules Septic Tank and Cesspool	47
Infiltration	Infiltration Tunnel	48
The modular system Carat S	The modular system Carat S	50
	Benefits of the Carat S system	52
	Choose your tank size	55
	Select your desired tank cover	56
	Choose your baffle position	58
	Choose your system pack	59
Carat underground tank	Carat XL underground tank	60
	Carat XXL underground tank	61
container.blue		62
Separator	Grease separator	67
	Light fluid separator	68



[www.graf.info](http://www.graf.info)



## Webcode G5101

**The webcode takes you straight to the information you need.**

- Installation instructions
- Dimensional drawings
- Accreditations
- Declarations of conformity

## Symbols used in this catalogue

### Load capacity



Suitable for pedestrian loading



Suitable for vehicle loading



Suitable for loading

# World of water

## Wastewater solutions

### Wastewater solutions for:

e.g. single-family homes



- **Klaro E Professional** (» page 12)
- **one2clean** (» page 24)
- **Anaerobix** (» page 42)
- **Septic tanks** (» page 44)

### Wastewater solutions for:

e.g. villages, office buildings,  
campsites, hotels

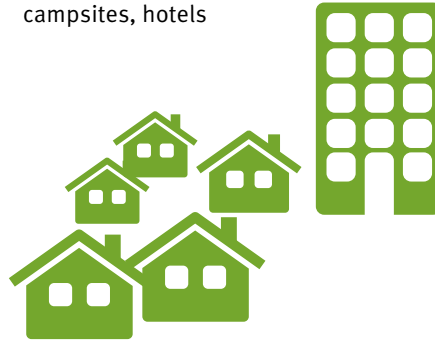

- **Klaro L | XL | XXL** (» page 32 | 34 | 35)
- **Moving Bed** (» page 33)
- **Klaro XXL Retrofitting** (» page 36)
- **container.blue** (» page 62)

### Wastewater solutions for:

e.g. holiday homes



- **Klaro E Professional** (» page 12)
- **Anaerobix** (» page 42)
- **Septic tanks** (» page 44)
- **Cesspools** (» page 45)





**Wastewater solutions for:**

e.g. temporary works,  
mining operations



- **container.blue** (» page 62)

**Wastewater solutions for:**

e.g. fuel stations, restaurants,  
vehicle workshops



- **Grease separator** (» page 67)
- **Light fluid separator** (» page 68)

# Small Biological Wastewater Treatment System

---





## System comparison

System	Klaro E Professional	one2clean
Page in catalogue for complete system conformity	12/13 EN 12566-3	24/25 EN 12566-3
Purifying technology	fully biological SBR lifting technology	fully biological SBR lifting technology
One-tank systems available up to	14 inhabitants   2,100 l/d	9 inhabitants   1,350 l/d
Multitank systems available up to	50 inhabitants   7,500 l/d	18 inhabitants   2,700 l/d
Maintenance interval	1–2 per year	1–2 per year
Warranty for underground tank	15 years	15 years
Warranty for purifying technology	3 years	3 years
<b>Control</b>		
+K Optional convenience package	○	—
+R Remote transmission (GSM modem)	○	—
+P Phosphate removal	○	—
+C Carbon infeed	○	—
+H Hygiene package (Disinfection)	○	—
+D Removal of nitrogen	○	●
Control power failure recognition	●	—
Temperature sensor to protect against overheating	○*	—
Logbook function	●	●
Operation	4 keys (○ 14 keys*)	4 keys
Serial interface for software updates	●	—
External control cabinet for installing control unit outdoors	○	○
Annual power consumption	346 kWh (8 inhabitants   1,200 l/h)	230 kWh (5 inhabitants   750 l/d)

● Standard equipment   ○ Available as options   — not available  
\* only in conjunction with optional convenience package +K

Parameter	Cleaning performance for Klaro E Professional	Cleaning performance for one2clean
COD (chemical oxygen demand)	91.9%	94.2%
BOD <sub>5</sub> (biochemical oxygen demand)	95.9%	98.0%
SS (suspended solids)	94.4%	96.3%
NH <sub>4</sub> -N	65.4%	98.3%
N <sub>total</sub>	57.1%	87.0%

Results of practical testing undertaken by the Prüfinstitut für Abwassertechnik (Testing Institute for Wastewater Technology), Aachen

# Klaro E Professional – Facts



## Why use the SBR system?

### How does SBR technology work?

Sequencing batch reactors or SBRs use a separate pre-treatment section to mechanically hold back solids and a biological aeration and settling tank. Small SBR wastewater treatment systems clean incoming wastewater over a number of cycles. GRAF products achieve a cleaning performance of up to 98%. In this respect the GRAF Klaro E Professional far surpasses legal minimum requirements.

- **Outstanding cleaning performance**  
Even during load fluctuations and underload
- **Excellent value for money**
- **Only 2 chambers required**
- **Only a small tank volume required**
- **Can be retrofitted in existing tanks**

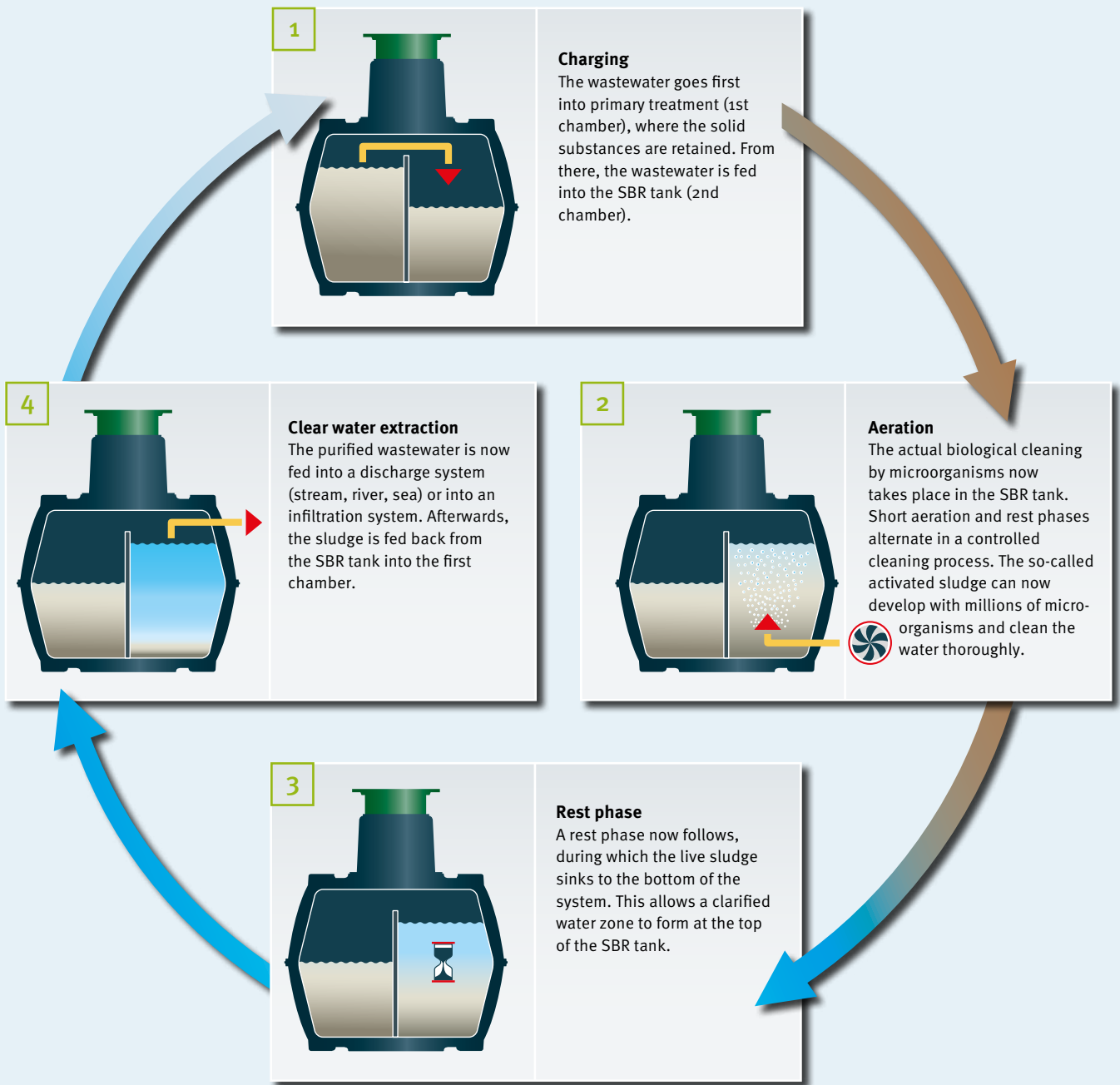

Function of the SBR wastewater treatment system Klaro  
**GRAF TV**  
[www.graf-water.com/graf-tv](http://www.graf-water.com/graf-tv)

# Klaro E Professional – Benefits

- ✓ No live electrical parts in the water
- ✓ Low power consumption
- ✓ Optional automatic adjustment to living situation (underload detection)
- ✓ Optional remote monitoring
- ✓ High-quality components mean low maintenance costs

## Wastewater tank

- ✓ Telescopic cover
- ✓ State-of-the-art manufacturing for maximum stability
- ✓ Suitable for vehicle loading in conjunction with telescopic vehicle dome shaft
- ✓ 100% watertight and corrosion-resistant
- ✓ Can be installed in groundwater







on wastewater tanks      on technology

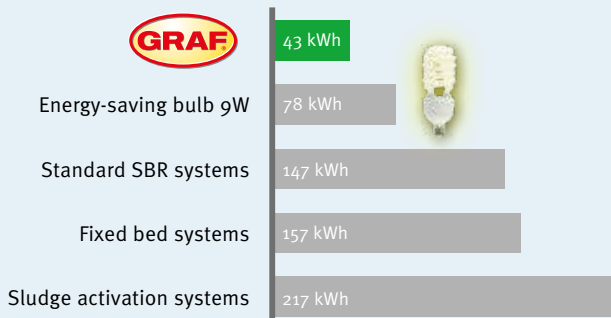

## Minimal power consumption per inhabitant<sup>1)</sup>

<sup>1)</sup>The diagram indicates the annual power consumption of various wastewater treatment systems. Source: "wwt", edition 6/2007 "The wastewater treatment system as a permanent solution", page 15, table 3, practical data; Klaro E Professional: test report by PIA (Prüfinstitut für Abwassertechnik GmbH, Testing Institute for Wastewater Technology), Aachen, test number PIA2011-141B15



### Super-quiet control cabinet

- ✓ Extremely low noise thanks to EPP housing and very quiet air compressor
- ✓ Battery-free power failure detection
- ✓ Very easy installation
- ✓ Interchangeable plug-in components



### High-tech installation kit

- ✓ Integrated self-cleaning sampling container
- ✓ Each lifter manufactured as a single piece. No connectors or screws necessary.
- ✓ Colour-coded and pre-assembled
- ✓ Special lifter design prevents sludge from leaking in
- ✓ Lifters easy to remove for maintenance without the use of tools

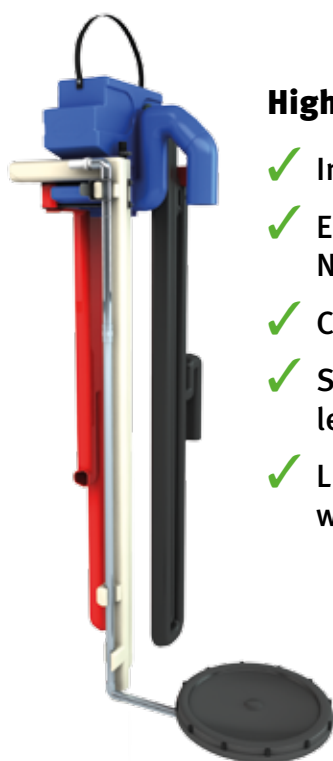

### Sealing cap DN 100

- ✓ Ensures no air or gas escapes from service duct
- ✓ No need for PU sealing foam
- ✓ Clean and professional solution



# Klaro E Professional

One-tank system



## Klaro E Professional one-tank system

[Webcode G5101](#)

Inhabitants [max.]	Max. daily flow [l/d]	Max. organic load [kg BOD <sub>5</sub> /d]	Total volume [l]	Volume [l]	Length [mm]	Width [mm]	Height [mm]	Weight [kg]
3-5	750	0.30	2,700	2,700	2080	1556	2010	140
5-8	1,200	0.48	3,750	3,750	2280	1755	2200	175
7-10	1,500	0.60	4,800	4,800	2280	1985	2430	220
9-14	2,100	0.84	6,500	6,500	2390	2190	2710	265

One complete system consists of: 1 Carat S underground tank with baffle, 1 tank dome, 1 telescopic dome shaft, Klaro E Professional system pack for one-tank system (➤ page 50 – the modular system). Please order the air hoses separately (accessories).





**Ideal for infiltration cleaned wastewater**

» page 48/49

## Accessories

» page 20/21



## Technical data

System	Klaro E Professional	
System conformity	EN 12566-3	
Purifying technology	fully biological SBR lifting technology	
One-tank systems available up to	14 inhabitants   2,100 l/d	
Maintenance interval	1 – 2 per year	
Warranty for underground tank	15 years	
Warranty for purifying technology	3 years	

Control	KL24base	KL24plus (+K)
Holiday / economy mode (underload detection)	Manual	Automatic
Back pressure monitoring	–	●
+R Remote transmission (GSM modem)	–	○
+P Phosphate removal	–	○
+C Carbon infeed	–	○
+H Hygiene package (Disinfection)	–	○
+D Removal of nitrogen	○	○
Control power failure recognition	●	●
Temperature sensor to protect against overheating	–	●
Logbook function	●	●
Operation	4 keys	14 keys
Serial interface for software updates	●	●
External control cabinet for installing control unit outdoors	○	○

● Standard equipment   ○ Available as options   – not available

Parameter	Cleaning performance for Klaro E Professional
COD (chemical oxygen demand)	91.9 %
BOD <sub>5</sub> (biochemical oxygen demand)	95.9 %
SS (suspended solids)	94.4 %
NH <sub>4</sub> -N	65.4 %
N <sub>total</sub>	57.1 %

Results of practical testing undertaken by the Prüfinstitut für Abwassertechnik (Testing Institute for Wastewater Technology), Aachen

# Klaro E Professional

Multitank system



## Klaro E Professional multitank system

[Q Webcode G5103](#)

Inhabitants [max.]	Max. daily flow [l/d]	Max. organic load [kg BOD <sub>5</sub> /d]	Total volume [l]	Volume [l]	Length* [mm]	Width* [mm]	Height [mm]	Weight [kg]
7-10	1,500	0.60	5,400	2x2,700	2680	1565	2010	120
12-16	2,400	0.96	7,500	2x3,750	5160	1755	2200	150
16-22	3,300	1.32	9600	2x4,800	5160	1985	2430	185
20-28	4,200	1.68	13,000	2x6,500	5380	2190	2710	220
25-32	4,800	1.92	15,000	4x3,750	10700	2000	2200	300
32-44	6,600	2.64	19,200	4x4,800	11100	2200	2430	370
42-50	7,500	3.00	26,000	4x6,500	11100	2200	2710	440

One complete system consists of: Carat S underground tanks, tank domes, telescopic dome shafts, Klaro E Professional system pack for multitank system (➤ page 50 – the modular system). Please order the air hoses separately (accessories).

## Klaro XL system – fully prefitted in the Carat XL underground tank

Inhabitants [max.]	Max. daily flow [l/d]	Max. organic load [kg BOD <sub>5</sub> /d]	Total volume [l]	Volume [l]	Length* [m]	Width* [m]	Height [mm]	Weight [kg]
38	5,700	2.28	17,000	2x8,500	7500	2040	2695	760
46	6,900	2.76	20,000	2x10,000	7540	2240	2895	912

Scope of supply: Carat XL underground tanks with factory-prefitted technology and control cabinet for internal fitting. The air hoses from the underground tanks to the control panel are not included. \*Total measurements



Ideal for infiltration  
cleaned wastewater



» page 48/49

## Accessories

» page 20/21



## Technical data

System	Klaro E Professional
System conformity	EN 12566-3
Purifying technology	fully biological SBR lifting technology
Multitank systems available up to	50 inhabitants   7,500 l/d
Maintenance interval	1 – 2 per year
Warranty for underground tank	15 years
Warranty for purifying technology	3 years

Control	KL24base	KL24plus (+K)
Holiday / economy mode (underload detection)	Manual	Automatic
Back pressure monitoring	–	●
+R Remote transmission (GSM modem)	–	○
+P Phosphate removal	–	○
+C Carbon infeed	–	○
+H Disinfection	–	○
+D Removal of nitrogen	○	○
+O Outlet with clear water pump	–	○
Control power failure recognition	●	●
Temperature sensor to protect against overheating	–	●
Logbook function	●	●
Operation	4 keys	14 keys
Serial interface for software updates	●	●
External control cabinet for installing control unit outdoors	○	○

● Standard equipment   ○ Available as options   – not available

Parameter	Cleaning performance for Klaro E Professional
COD (chemical oxygen demand)	91.9 %
BOD <sub>5</sub> (biochemical oxygen demand)	95.9 %
SS (suspended solids)	94.4 %
NH <sub>4</sub> -N	65.4 %
N <sub>total</sub>	57.1 %

Results of practical testing undertaken by the Prüfinstitut für Abwassertechnik (Testing Institute for Wastewater Technology), Aachen

# Accessories



## Plastic external control cabinet

for 2 – 10 inhabitants (up to 1,500 l/d)

Order no. 107773



for 10 – 28 inhabitants  
(1,800 – 4,200 l/d)

The image shows the external control cabinet for 2 – 10 inhabitants with LED warning light (accessories available on request)

### Benefits

- Easy access for the maintenance fitter
- Function checking is simple as the control unit is located immediately next to the system
- Ideal solution for large distances from the house (> 20 m)
- Flexible use of the proven GRAF EPP control cabinet in a plastic external column (size 2 – 10 inhabitants)
- Lockable housing in sturdy, weather-resistant plastic
- Integrated double power socket for easy maintenance

### Easy, flexible application for the GRAF EPP control cabinet



EPP control cabinet  
Part of the wastewater treatment system



GRAF Plastics external control cabinet for EP control cabinet (size 2 – 10 inhabitants)



Ground level

### +K Convenience package

Convenience package: control with larger display and keypad. Underload detection by a pressure sensor in the control.

On request

#### KL24plus



- SD card slot for easy logbook transfer
- Automatic underload detection
- Suitable for phosphate precipitation and UV module
- Large display and 14 keys for comfortable operation
- Automatic logging
- Battery-free power failure detection
- High-contrast display with blue backlighting
- Durable, gas-tight membrane keypad

### +O Outlet with clear water pump

Lift the clear water when the outlet pipe is lower than the water course.

On request



### +D Removal of nitrogen

The +D package for denitrification (removal of nitrogen) results in the clarified water quality satisfying very strict requirements. The GRAF systems thereby attain a  $N_{\text{total}}$  value (total parameters of inorganic nitrogen compounds) of less than 25 mg/l.

Order no. 107520

### +P Phosphate removal package

Phosphate in water results in a massive build-up of algae. The GRAF +P package ensures the safe removal of phosphate and therefore great water quality

On request

### +C Carbon infeed

#### Solution for weekend homes

The addition of carbon as a nutrient allows the purification process to continue and prevents the biology from dying off.

On request



### +R Remote transmission

Remote monitoring allows error messages to be transmitted to mobile phones and operating data to be queried by text message. Convenient remote wastewater treatment system control by GSM is also possible.

- Greater efficiency
- Greater operating reliability
- Optimised service intervals
- Greater customer benefit thanks to monitoring service
- Low-cost remote diagnosis in the event of a fault without the service fitter having to come on site

Order no. 107117



### +H Hygiene package

Disinfection using the +H package satisfies even the most stringent of purity requirements for a GRAF wastewater treatment system. Without the use of chemical substances, it reliably kills off germs and microorganisms. The clarified water therefore complies with the EU Bathing Water Directive.

On request

- Easy to operate
- Maintenance-friendly thanks to easy-to-remove module
- Fitted in downstream shaft



## Accessories for small wastewater treatment systems

### Sampling point, internal

For two- and multitank systems

Order no. 107170



### Empty pipe seal DN 100

- Gas-tight seal for empty pipe
- No insulating foam required
- Clean, professional solution

Order no. 107613

### Convenient connection set

For external control cabinets for 2 – 10 inhabitants. Air hoses (colour-coded) and DN 100 empty pipe seal

Order no. 107651

### Voltage transformer

- From 110 V – 230 V
- Up to 300 W (LA 200)

Order no. 107421

### Odour filter

For DN 100 ventilation openings; reliably filters out unpleasant odours; filter insert of multi-layer mesh with impregnated activated carbon

Order no. 104018

### Filter insert

For odour filter; replace at least every two years or when odour is perceptible

Order no. 104024



### Filling granulat for external cabinets

Prevents soil moisture from rising into the external control cabinet. Required amount: 1 bag per external control cabinet for 12 – 28 inhabitants; 50 l bag

Order no. 107607

### SBR hose package

Includes: 1 x Ø 19 mm and 3 x Ø 13 mm PVC hose; colour-coded for Klaro system

Length: 5 m

Order no. 107189

Length: 10 m

Order no. 107190

Length: 15 m

Order no. 107191

Length: 20 m

Order no. 107192

# Klaro E Professional for retrofitting

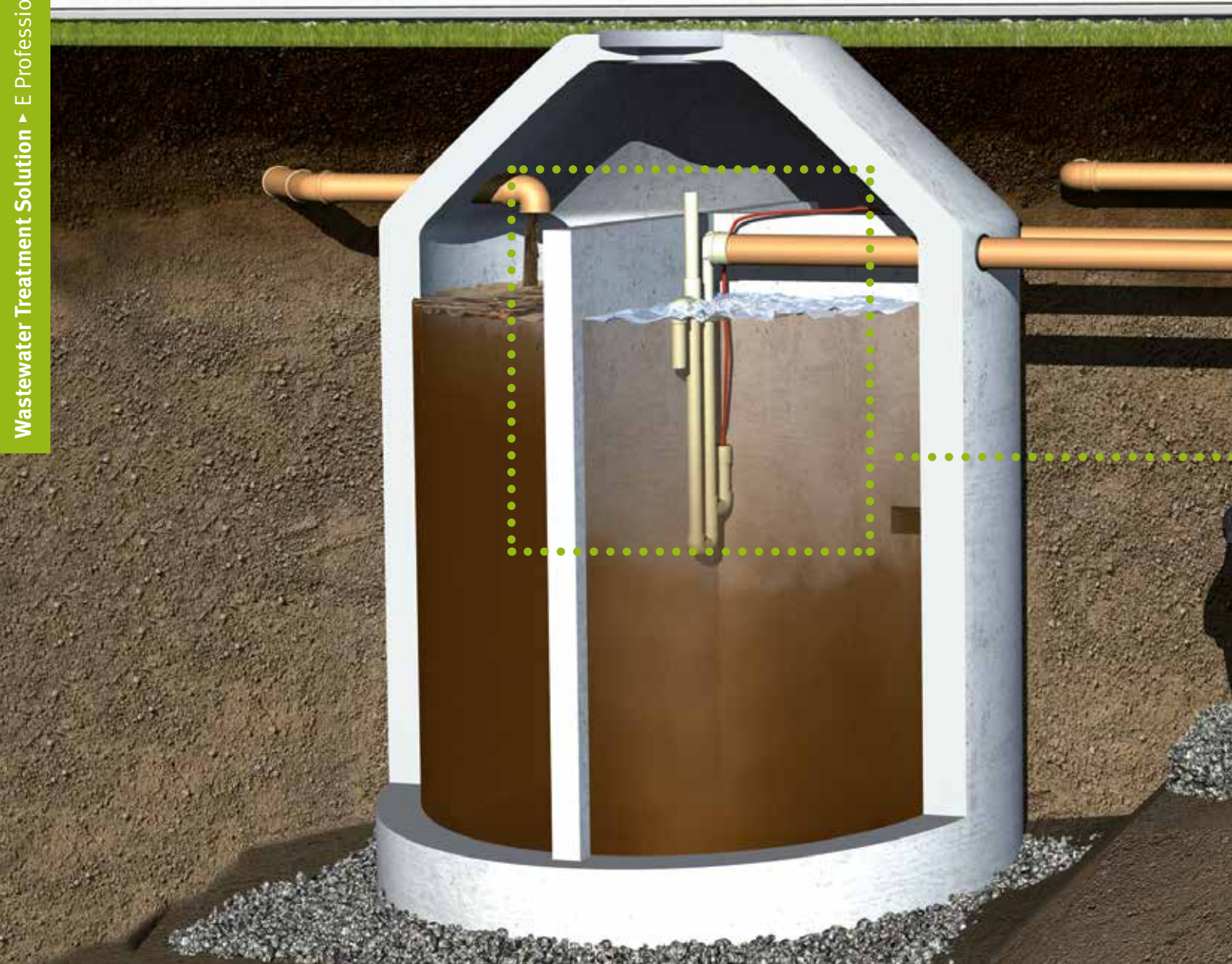

**Want to bring your multi-chamber pit  
bang up to date? Then get in touch!**

The GRAF system packs allow existing tanks to be used with the proven GRAF Klaro E Professional.

## Retrofitting – what needs to be done?

- Empty and clean pit
- Test tank to ensure leak-tightness / seal the baffle
- Measure existing pit: baffle height, diameter / depth dimensions
- Contact GRAF

*airlift*.blue



**airlift.blue**  
 System pack for retrofitting  
 up to 28 inhab.  
 Compressor as required  
 Order no. 107346



Image shows Systeme pack for retrofitting > 28 inhabitants)

**Our experienced team**  
 takes all local circumstances  
 into account to dimension  
 your required system-pack



## Why use the one2clean system?

**As much technology as necessary, as little technology as possible.**

Over the past few years, wastewater treatment systems have experienced impressive technological developments. Today, they are high-tech products equipped with sophisticated controls and various pumps, sensors and valves. Yet this is often to the detriment of the product's reliability. A reliable wastewater disposal system no longer needs to be complicated. one2clean is an advanced development of the proven SBR wastewater treatment technology, with considerable advantages in terms of operating costs and safety.

- **Excellent cleaning performance**  
Even during load fluctuations and underload
- **Great value for money**
- **Double sludge storage volume**
- **Low sludge removal**



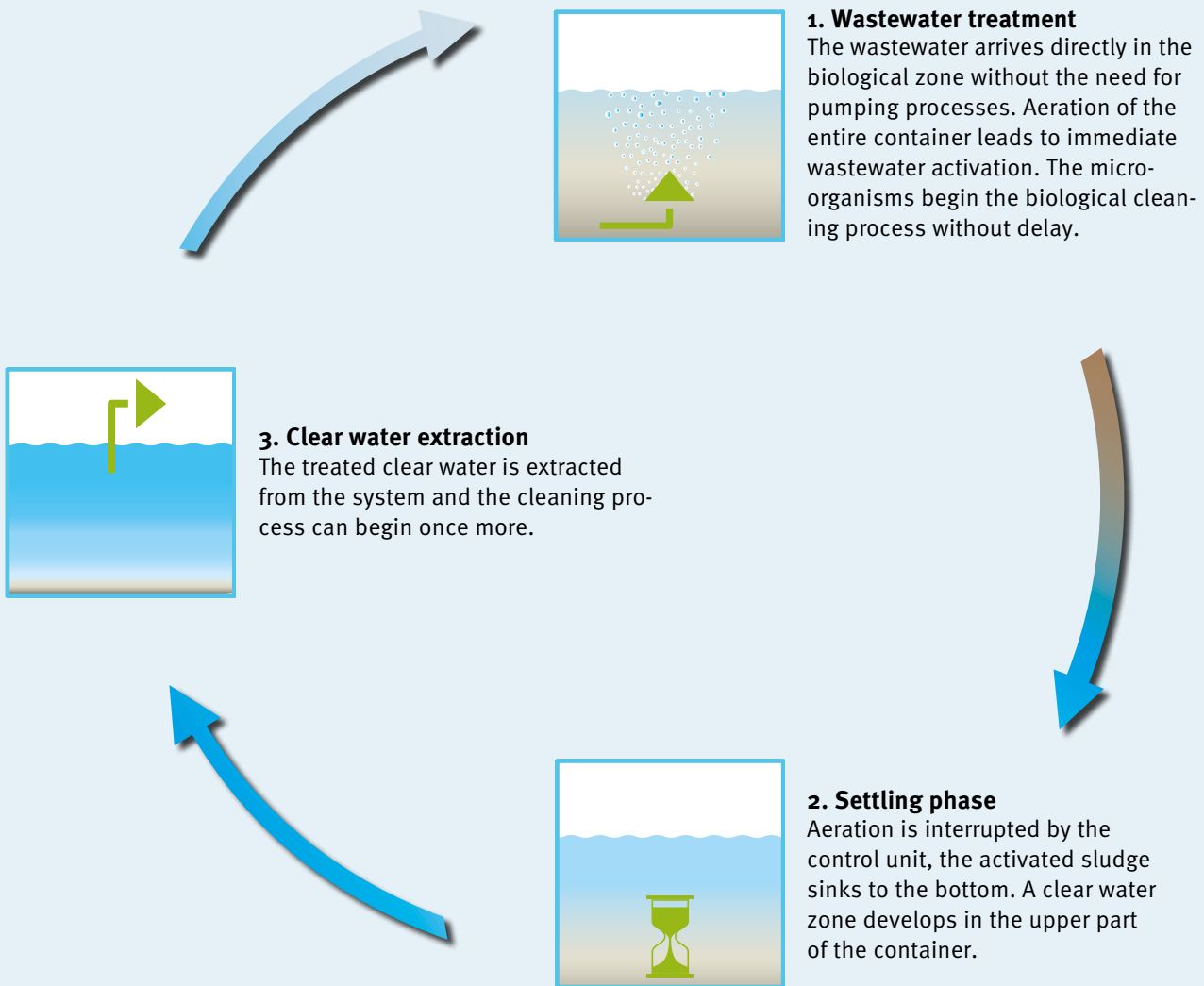

**one2clean only needs 3 steps to produce clear water**

The wastewater treatment is carried out in one chamber in just one tank. This eliminates unnecessary pumping processes and sludge return.

**one2clean is odourless**

The entire volume of wastewater is immediately activated with oxygen using the unique one2clean technology. The final process of the one2clean produces an odourless, clear treated water for extraction to soakaway or waterway \*

**one2clean already meets the needs of tomorrow**

The one2clean wastewater treatment system can achieve sustainable discharge values with an efficiency factor of up to 99%! This offers high investment security – even if legal requirements become stricter.

\* Manufacturer's operating and installation instructions must be adhered to.

# one2clean – Benefits

- ✓ Only one tank with just one chamber required
- ✓ Less energy consumption and less wear
- ✓ No mechanical elements in the wastewater
- ✓ No pumps in the wastewater
- ✓ No electrical components in the wastewater
- ✓ Incredibly low volume of sewage sludge

## Wastewater tank

- ✓ Telescopic cover
- ✓ State-of-the-art manufacturing for maximum stability
- ✓ Suitable for vehicle loading in conjunction with telescopic vehicle dome shaft
- ✓ 100% watertight and corrosion-resistant
- ✓ Can be installed in groundwater



on wastewater tanks



on technology



### Incredibly low volume of sewage sludge

Aeration of the entire wastewater tank

- Immediate wastewater activation
- Minimisation of the sludge
- Less sludge removal
- Cost savings

### Minimum maintenance costs

- Simple construction
- High-quality components
- As much technology as necessary, as little technology as possible.
- Integrated sampling point

### Minimum power consumption

- one2clean has only one pumping process, reducing energy consumption and running costs
- Economical motor valve
- Energy-optimised membrane compressor

Conventional wastewater treatment systems



one2clean



Only 46 kWh per person and per year!



### one2clean system control

- ✓ The one2clean has a compact controller
- ✓ The microprocessor control system ensures simple operation and maintenance
- ✓ Ultra-quiet thanks to silent diaphragm compressor
- ✓ Automatic power failure detection



**MINIMAL OPERATING COSTS**

### +C Doser

- ✓ Suitable for holiday houses thanks to the optional +C module.



### one2clean set-up kit

- ✓ Conventional wastewater treatment systems require up to three pumping processes. one2clean only requires one pumping process, which saves energy and extends the lifetime of the air compressor – the core part of the system.
- ✓ Rugged clear water lifter manufactured in one seamless piece. No connectors or screws necessary.
- ✓ Simple maintenance via an integrated, self-cleaning sampling container.

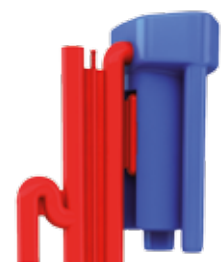

**EFFICIENCY FACTOR OF UP TO 99 %**



# one2clean

One-tank and two-tank systems



on wastewater tanks



on technology



## One-tank system

[Q Webcode G5104](#)

Inhabitants [max.]	Max. daily flow [l/d]	Max. organic load [kg BOD <sub>5</sub> /d]	Total volume [l]	Volume [l]	Length [mm]	Width [mm]	Height [mm]	Weight [kg]
1-3	450	0.18	2,700	2,700	2080	1556	1690	120
4-5	750	0.3	3,750	3,750	2280	1755	1880	150
6-7	1,050	0.42	4,800	4,800	2280	1985	2110	185
8-9	1,350	0.54	6,500	6,500	2390	2190	2390	220

## Two-tank system

[Q Webcode G5105](#)

Inhabitants [max.]	Max. daily flow [l/d]	Max. organic load [kg BOD <sub>5</sub> /d]	Total volume [l]	Volume [l]	Length [mm]	Width [mm]	Height [mm]	Weight [kg]
1-7	1,050	0.42	5,400	2 x 2,700	4760	1556	1690	240
8-10	1,500	0.6	7,500	2 x 3,750	5160	1755	1880	300
11-14	2,100	0.84	9,600	2 x 4,800	5160	1985	2110	370
15-18	2,700	1.08	13,000	2 x 6,500	5380	2190	2390	440



Ideal for infiltration cleaned wastewater



>> page 48/49

## Technical data



System	one2clean
System conformity	EN 12566-3
Purifying technology	fully biological SBR lifting technology
One-tank systems available up to	9 inhabitants   1,350 l/d
Two-tank systems available up to	18 inhabitants   2,700 l/d
Maintenance interval	1 – 2 per year
Warranty for underground tank	15 years
Warranty for purifying technology	3 years

### Control

Holiday mode	Manual
+D Removal of nitrogen	●
+C Carbon infeed	○
Logbook function	●
Operation	4 keys
External control cabinet for installing control unit outdoors	○
Annual power consumption	230 kWh (5 inhabitants   750 l/d)

● Standard equipment    ○ Available as options

### Parameter

COD (chemical oxygen demand)	94,2 %
BOD <sub>5</sub> (biochemical oxygen demand)	98,0 %
SS (suspended solids)	96,3 %
NH <sub>4</sub> -N	98,3 %
N <sub>total</sub>	87,0 %

Results of practical testing undertaken by the Prüfinstitut für Abwassertechnik (Testing Institute for Wastewater Technology), Aachen

## Accessories:

GRAF EPP control cabinet for 1 – 18 inhabitants Plastic external cabinet

>> page 20



# Large Biological Wastewater Treatment Systems

---





## System comparison

System	Klaro L   XL   XXL	Moving Bed
Page in catalogue for complete System conformity	32 – 39 ATV A-122	33 ATV A-122
Purifying technology	fully biological SBR lifting technology	fully biological Moving bed technology
XXL systems available up to	1000 inhabitants   150,000 l/d	200 inhabitants   30,000 l/d
Maintenance interval	2 – 4 per year	2 – 4 per year
Warranty for underground tank	15 years	15 years
Warranty for purifying technology	3 years	3 years
Warranty for carrier material		15 years
<b>Control</b>		
+R Remote transmission (GSM modem)	○	—
+P Phosphate removal	○	—
+C Carbon infeed	○	—
+H Disinfection	○	—
+D Removal of nitrogen	○	—
Control power failure recognition	●	●
Temperature sensor to protect against overheating	●	●
Logbook function	●	●
Operation	○ 14 keys	14 keys
Serial interface for software updates	●	—
External control cabinet for installing control unit outdoors	○	○

● Standard equipment    ○ Available as options    — not available

# Large Biological Wastewater Treatment Plants

up to 200 inhabitants for the Carat S



## Klaro L system for the Carat S underground tank

[Webcode G5106](#)

Inhab. [max.]	Max. daily flow [l/d]	Max. organic load [kg BOD <sub>5</sub> /d]	Total number of tanks	Primary treatment [capacity in l]	SBR tank [capacity in l]	Required air hoses [quantity x Ø mm]	Length* [m]	Width* [m]
60	9,000	3.60	4	2 x 6,500	2 x 6,500	6 x 19	11.10	2.20
90	13,500	5.40	5	2 x 6,500	3 x 6,500	9 x 19	11.10	4.90
120	18,000	7.20	7	3 x 6,500	4 x 6,500	12 x 19	11.10	4.90
150	22,500	9.00	9	4 x 6,500	5 x 6,500	14 x 19	14.00	4.90
180	27,000	10.80	10	4 x 6,500	6 x 6,500	16 x 19	11.10	7.60

\*Total measurements (>> page 50 – the modular system)

### Options



The proven options of the system Klaro E Professional are also available on request for large systems.





## The choice is yours

There are two purification systems available for converting large systems: Moving Bed and Klaro L, both available in sizes for up to 200 inhabitants. On request, for large systems you also have the choice of the proven options of the Klaro E Professional system, such as phosphate removal or additional disinfection of the cleaned wastewater with UV light.

## Property consultation – Planning and sizing

Large systems must always be adapted to individual requirements, such as cleaning performance or official regulations.

When sizing a large system, you must take many basic factors into account. GRAF is happy to support you with the individual planning of this type of project and will gladly create an individual sizing for your property.

## Accessories

### SBR hose Ø 19 mm

red	Order no. 934166
blue	Order no. 934162
black	Order no. 934189
transparent	Order no. 934163

### Compact dosing pump

0–37 ml/min

Order no. 107348

### Sampling point, internal

For multitank systems

Order no. 107170



### Outdoor steel cabinet XL

For 60–150 inhabitants

On request

### Outdoor concrete cabinet

For 180–200 inhabitants

On request

Further accessories (» page 20/21)

## Moving Bed system for the Carat S underground tank

Webcode G5107

Inhab. [max.]	Max. daily flow [l/d]	Max. organic load [kg BOD <sub>5</sub> /d]	Total number of tanks	Primary treatment [capacity in l]	Moving bed [capacity in l]	Final treatment [capacity in l]	Sludge storage [capacity in l]	Length* [m]	Width* [m]
20	3,000	1.20	4	2 x 3,750	1 x 2,700	1 x 2,700	–	10.20	1.80
28	4,200	1.68	4	2 x 4,800	1 x 3,750	1 x 3,750**	–	10.60	2.00
36	5,400	2.16	4	2 x 6,500	1 x 3,750	1 x 3,750**	–	10.80	2.20
44	6,600	2.64	4	2 x 6,500	1 x 3,750	1 x 3,750**	–	10.80	2.20
50	7,500	3.00	5	3 x 4,800	1 x 4,800	1 x 4,800**	–	13.40	2.20
70	10,500	4.20	5	3 x 4,800	1 x 6,500	1 x 6,500**	–	13.62	2.20
90	13,500	5.40	8	3 x 6,500	2 x 4,800	2 x 4,800	1 x 4,800	10.62	7.16
120	18,000	7.20	9	4 x 6,500	2 x 6,500	2 x 6,500	1 x 6,500	11.06	7.27
140	21,000	8.40	9	4 x 6,500	2 x 6,500	2 x 6,500	1 x 6,500	11.06	7.57
160	24,000	9.60	11	5 x 6,500	3 x 6,500	2 x 6,500	1 x 6,500	13.95	7.57
200	30,000	12.00	12	5 x 6,500	3 x 6,500	2 x 6,500	2 x 6,500	13.95	7.57

\*Total measurements / \*\*One baffle required (» page 50 – the modular system)

# Large Biological Wastewater Treatment Plants

up to 300 inhabitants for the Carat XL and Carat XXL



## Klaro XL system – fully prefitted in the Carat XL underground tank

Q Webcode G5108

Inhab. [max.]	Max. daily flow [l/d]	Max. organic load [kg BOD <sub>5</sub> /d]	Total number of tanks	Primary treatment [capacity in l]	SBR tank [capacity in l]	Required air hoses [quantity x Ø mm]	Length* [m]	Width* [m]	Order no.
80	12,000	4.80	4	2 x 8,500	2 x 8,500	6 x 19	15.50	2.04	106172
100	15,000	6.00	4	2 x 10,000	2 x 10,000	6x19	15.58	2.24	106173
120	18,000	7.20	5	2x8,500	3x8,500	9x19	11.50	7.12	106174
145	21,750	8.70	5	2x10,000	3x10,000	9x19	11.56	7.72	106175
165	24,750	9.90	7	3x8,500	4x8,500	12x19	7.50	9.66	106176
200	30,000	12.00	7	3x10,000	4x10,000	12x19	7.54	10.46	106177

Scope of supply: Carat XL underground tanks with factory-prefitted technology and control cabinet for internal fitting. The air hoses from the underground tanks to the control panel are not included. \*Total measurements

## Accessories

### SBR hose Ø 25mm

transparent  Order no. 934002

### Compact dosing pump

0 – 37 ml/min

Order no. 107348

## Options

**+D +P +C +H +R**

» page 21



## Klaro XXL system – fully prefitted in the Carat XXL underground tank

Q Webcode G5109

Inhab. [max.]	Max. daily flow [l/d]	Max. organic load [kg BOD <sub>5</sub> /d]	Total number of tanks	Primary treatment [capacity in l]	SBR tank [capacity in l]	Required air hoses [quantity x Ø mm]	Length* [m]	Width* [m]	Order no.
100	15,000	6.00	2	1x16,000	1x16,000	6x19	15.50	2.04	107757
165	24,750	9.90	2	1x26,000	1x26,000	6x19	15.58	2.24	107758
200	30,000	12.00	4	2x16,000	2x16,000	9x19	11.50	7.12	107759
300	45,000	18.00	4	2x26,000	2x26,000	9x19	11.56	7.72	107760

Scope of supply: Carat XXL underground tanks with factory-prefitted technology and control cabinet for internal fitting. The air hoses from the underground tanks to the control panel are not included. \*Total measurements



### Steel cabinet XL

For 60 – 150 inhabitants

On request

### Sampling point, internal

For multitank systems

Order no. 107170

### Concrete cabinet

For 180 – 200 inhabitants

On request

### Sampling point, external

For multitank systems

On request

Further accessories (» page 20/21)

# Large Biological Wastewater Treatment System

Klaro XXL Retrofitting up to 1000 inhabitants for concrete tanks (onsite concrete)

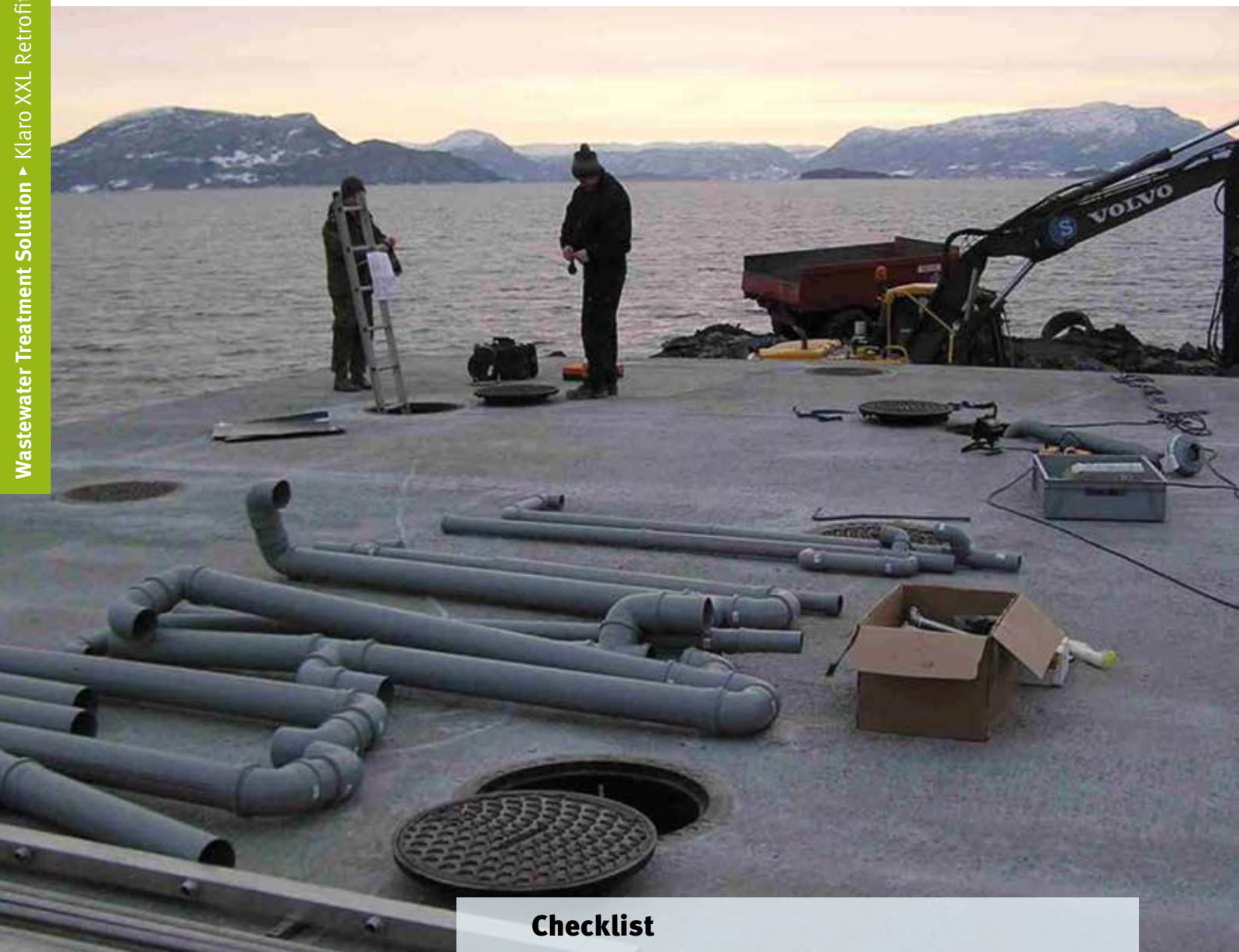

## Checklist

To plan your system, we need the following information:

- **What type of project?**  
(Domestic, hotel, commercial etc.)
- **How many people will use the system and what is the water consumption per head?**
- **What legal requirements apply to wastewater at the location?**
- **Local power grid**

## Special requirements

Systems for more than 50 inhabitants work on the same principle as small wastewater treatment systems and use the SBR process. Because of the special requirements involved, all systems for more than 50 inhabitants are planned as individual projects. Our experienced team of engineers and technicians will help you to plan your project. We take all local circumstances into account from the concept planning phase to implementation.

# Technical Components

In systems for over 50 inhabitants, the technical components are securely housed in the control cabinet or a plant room. The standard technical components of a wastewater treatment system include:

- Air compressor
- Magnetic distributor manifold
- Microprocessor controller
- Cooling fan
- Main switch

## Internal control cabinet



XL metal internal cabinet

## External control cabinets



L metal external cabinet



XL metal external cabinet



Concrete external cabinet

## Machine technique

As an alternative to a conventional control cabinet, the technical components can be installed in a dedicated room or machine house. This guarantees sufficient space for all the necessary components and maximum flexibility.



Example: Installation in a Machine house



Example: Installation in an existing plant room

# Technical Components

## Components in the pit

The main components of a wastewater treatment system must be suitable for the local requirements and the pit in terms of size, shape and performance

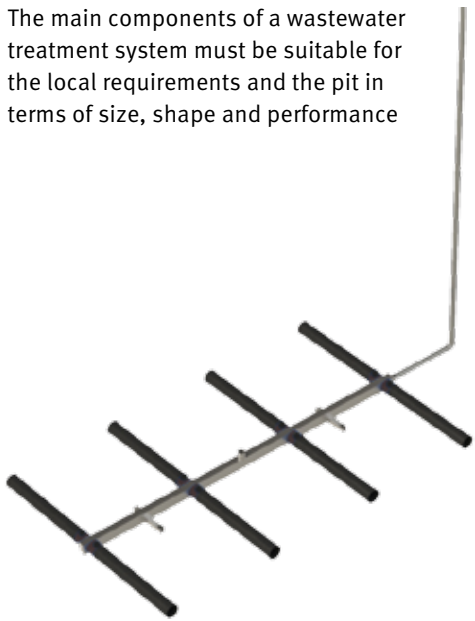

Aerator unit



Air lifts

## Additional technical components

The modular design of our treatment technology allows various additional components to be added at any time. These include:

- Dosing technology (e.g. for phosphate precipitation)
- UV hygiene module (Disinfection)
- Warning lights
- Soundproof hood for air compressor
- Remote monitoring



UV module



**Concept dosing pump**  
0 – 74 ml/min  
for level control of precipitant

## Accessories

### SBR hose Ø 25 mm

transparent  Order no. 934002

### Sampling point, internal

Order no. 107170

Further accessories ([»](#) page 20/21)

## Options

**+D +P +C +H +R**

[»](#) page 21

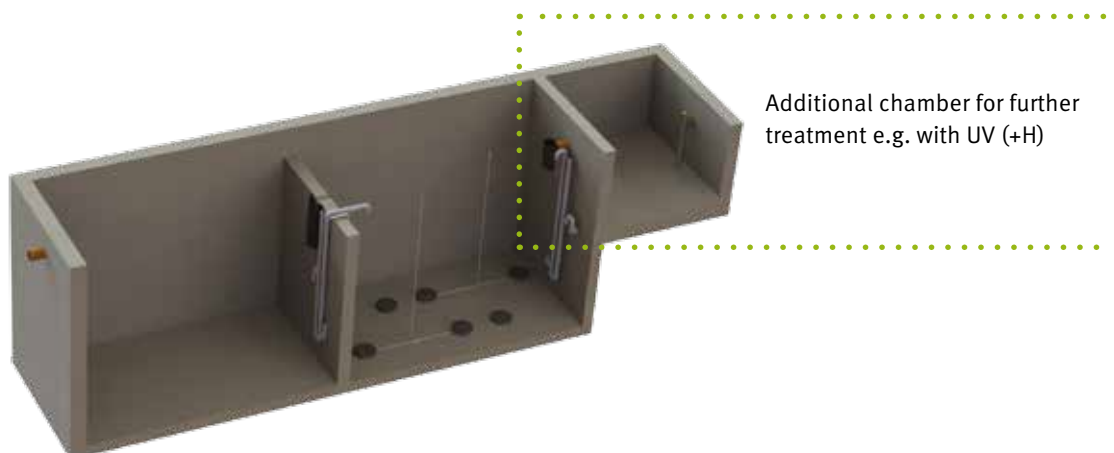

Example: cutaway view of a 50-inhabitant system

Additional chamber for further treatment e.g. with UV (+H)

Inhabitants [max.]	Max. daily flow [m <sup>3</sup> /d]	Max. organicload [kg BOD <sub>5</sub> /d]	Water depth [mm]	Sludge / buffer [mm]	SBR chamber [mm]	Compressor
100	15	6.00	2500	2800 x 2900	2800 x 2900	DTN 41
200	30	12.00	2750	2800 x 5400	2800 x 5400	KDT 3.80
300	45	18.00	3000	2800 x 7500	2800 x 7500	KDT 3100
400	60	24.00	3000	5500 x 4900	5500 x 4900	KDT 3140
500	75	3.00	3000	5500 x 6400	5500 x 6400	KDT 3.140

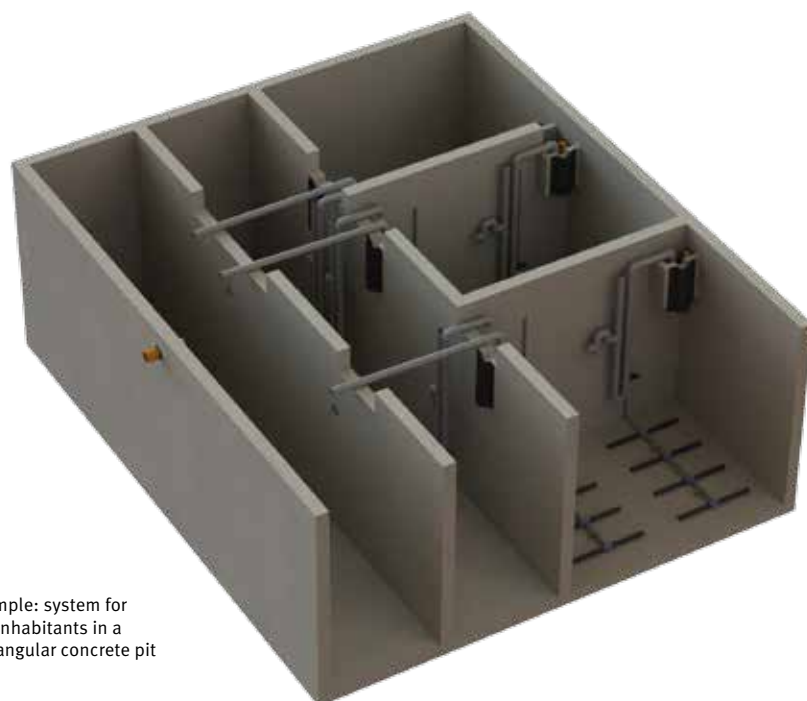

Example: system for 411 inhabitants in a rectangular concrete pit

**Our experienced team** will help you to plan your project. We take all local circumstances into account from the concept planning phase to implementation.

Inhabitants [max.]	Max. daily flow [m <sup>3</sup> /d]	Max. organicload [kg BOD <sub>5</sub> /d]	Water depth [mm]	Sludge / buffer [mm]	SBR chamber [mm]	Compressor
600	90	36,00	3000	5800 x 6600	2 x 2800 x 7500	2 x KDT 3100
700	105	42,00	3000	11 200 x 3900	2 x 5500 x 4300	2 x KDT 3100
800	120	48,00	3000	11200 x 4500	2 x 5500 x 4900	2 x KDT 3140
900	135	54,00	3000	11 200 x 5000	2 x 5500 x 5500	2 x KDT 3140
1000	150	60,00	3000	11 200 x 5600	2 x 5500 x 6400	2 x KDT 3140

# Mechanical Wastewater Treatment Systems

---





## System comparison

System	Anaerobix	Septic Tanks	Cesspools
Page in catalogue for complete	42/43	44/47	45 – 47
System conformity	—	EN 12566-1	—
Purifying technology	anaerobic process	mechanical separation	—
Warranty for underground tank	15 years	15 years	15 years
Warranty for purifying technology	3 years	—	—

### Limit values

BOD <sub>5</sub> (biochemical oxygen demand)	75 %	50 – 65 %	—
SS (suspended solids)	90 %	60 – 70 %	—



Anaerobix



Carat S



Carat XL



Carat XXL



Platin



Herkules

# Anaerobix – Wastewater Treatment System with Biological Filter



## Simple and low-cost

- Anaerobix is the new low-cost anaerobic filter system for wastewater tanks in Graf tanks
- Filled with the carrier material supplied, it increases the cleaning performance of a wastewater tank several times over. The large surface of the recyclable plastic carrier material (141 m<sup>2</sup>/m<sup>3</sup>) allows the biofilm responsible for the cleaning process to cover a large area.

## The benefits of the Anaerobix system at a glance

- Very good cleaning performance: efficiency over 90%, PIA-certified (Testing Institute for Waste Water Technology)
- No power consumed, no electrical or mechanical components (e.g. pumps or float switch) in tank
- Largely maintenance-free
- Installation in proven Graf tanks
- Easy to install with standard DN 100 pipes
- Very good value for money

### Anaerobix single-tank system

**Webcode** G5503

Tank volume	2,700 litres	3,750 litres	4,800 litres	6,500 litres
Max. daily flow [l]	1,200	2,250	2,850	3,750



**Ideal for infiltration cleaned wastewater**

>> page 48/49



PIA, independent testing institute in Aachen

### Technical data



System	Anaerobix
Purifying technology	Anaerobic system
One-tank systems available up to	3,750 l/d
Maintenance interval	1–2 per year
Warranty for underground tank	15 years

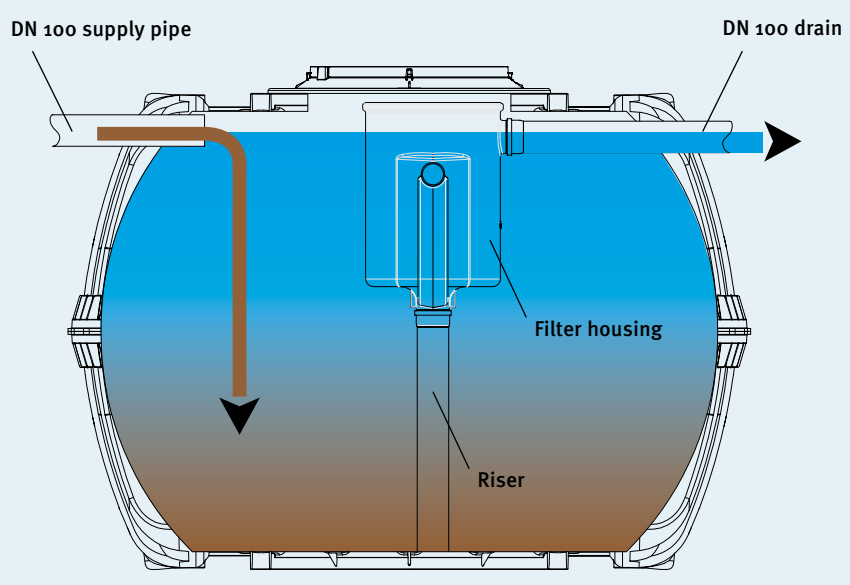
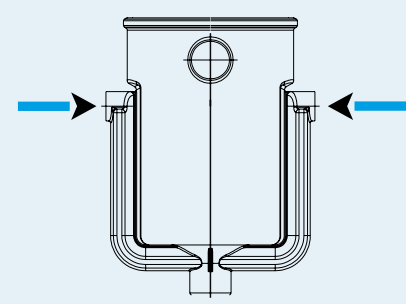

Limit values	
BOD <sub>5</sub> (biochemical oxygen demand)	75 %
SS (suspended solids)	90 %

# Carat S Septic Tank

Three chambers / Two chambers / One chamber

Floating and removable material is extracted from domestic wastewater in mechanical wastewater tanks. This is purely mechanical cleaning.

## Benefits

- Up to 45 wastewater tanks per lorry
- Low weight: can also be installed in difficult local conditions without a crane
- Reasonable purchase and installation costs. Compare!
- Low maintenance: maintenance or cleaning work can be performed through the shafts
- Tanks can be used as rainwater harvesting systems after thorough cleaning



**12566-1\***

Hydraulic efficiency **99.9%**

\*Refer to the installation instructions for CE-compliant Septic tanks

## Carat S Septic tank

[Webcode G5501](#)

Inhabitants [max]	Total volume [l]	Capacity [l]	Length [mm]	Width [mm]	Height [mm]	Weight [kg]
5	2,700	2,700	2080	1565	2010	145
7	3,750	3,750	2280	1755	2200	175
9	4,800	4,800	2280	1985	2430	220
13	6,500	6,500	2390	2190	2710	260

One complete system consists of: Carat S underground tank with baffle. Also available without baffle as a one-chamber wastewater tank. (>> page 57 – suitable covers >> page 58 – different baffle position)

## Accessories

**Inspection end DN 200**  
For Carat S 4,800 l and 6,500 l  
Order no. 340527



**Deaeration end DN 100**  
Order no. 369017



Presenting the Carat wastewater tank

**GRAF TV**  
[www.graf-water.com/graf-tv](http://www.graf-water.com/graf-tv)



## Benefits

- Easy installation due to low net weight
- The tank can also be used as a rainwater collection tank after cleaning
- Can be expanded as required.



## Carat S underground tank Cesspool (» page 57 – suitable covers)

[Q Webcode G5408](#)

Volume [l]	Length [mm]	Width [mm]	Height [mm]	Weight [kg]
2,700	2,080	1565	2010	120
3,750	2,280	1755	2200	150
4,850	2,280	1985	2430	185
6,500	2,390	2190	2710	220

## Carat XL underground tank Cesspool (» page 57 – suitable covers)

[Q Webcode G5409](#)

Volume [l]	Length [mm]	Width [mm]	Height [mm]	Weight [kg]
8,500	3500	2040	2695	380
10,000	3520	2240	2895	456

## Carat XXL underground tank Cesspool (» page 57 – suitable covers)

[Q Webcode G5410](#)

Volume [l]	Length [mm]	Width [mm]	Height [mm]	Weight [kg]
16,000	4660	2500	2550	805
36,000	9430	2500	2550	1495
56,000	14200	2500	2550	2185
76,000	18970	2500	2550	2875

Other sizes » page 61 / up to 102.000 litres on request

## Accessories

### Overflow guard

Emits visual and audio alarm, battery-operated (9 V).

Order no. 351017



### Odour filter for ventilation shaft

Reliably filters out unpleasant odours.

Order no. 104018



### Special seal DN 100

For connections

Order no. 332033

### Drill DN 100

With view shaft

Order no. 202003

# Platin Cesspool

## Benefits

- Can be installed in groundwater
- Shallow installation
- Easy installation due to low net weight
- The tank can also be used as a rainwater collection tank after cleaning.
- Can be expanded as required

## Volume

Volume [l]	Order no.
1,500	390000
3,000	390001
5,000	390002
7,500	390005

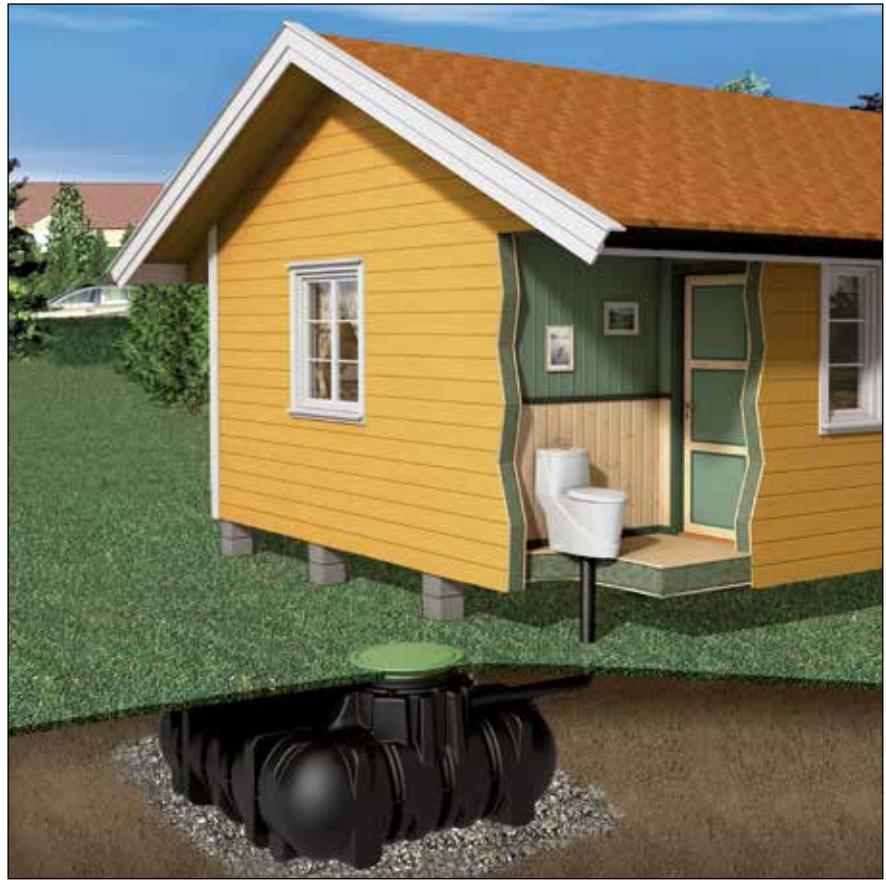

## Technical data

Q Webcode G5411

Volume [l]	Width b [mm]	Length l [mm]	Height h [mm]	Height h <sub>tot</sub> [mm]	Height of dome shaft ht [mm]	Internal Ø of dome shaft [mm]	Weight [kg]
1,500	1250	2100	700	1015	315	650	82
3,000	2100	2450	735	1050	315	650	180
5,000	2300	2890	950	1265	315	650	250
7,500	2250	3600	1250	1565	315	650	360

## Technical data

Max. earth covering (without groundwater vehicle loading)	1200 mm
Max. axle load	2.2 t
Max. total weight	3.5 t
Earth covering required for vehicle loading	700 mm – 1000 mm
Groundwater stability	up to tank shoulder
Earth covering required for groundwater stability	700 mm – 1200 mm
Connection	4 x DN 100

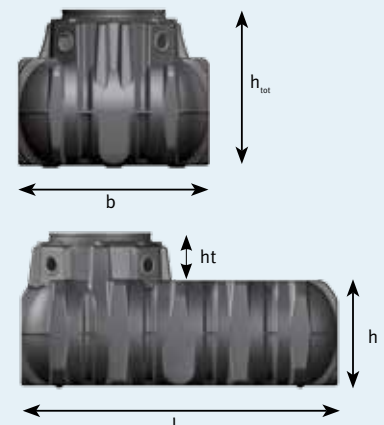

# Herkules Septic Tank / Cesspool

For overground and underground installation



## Benefits

- Stability tested according to European standard (DIN EN 12566-3)
- Construction approved by DIBt for domestic wastewater
- Can be installed in groundwater
- Fits through any door (80 cm) – each half-shell weighs just 30 kg
- Fast tank fitting with profile seal and patented fast connectors
- Tanks can be used for rainwater harvesting systems after thorough cleaning
- Can be expanded as required

## Herkules tank 1,600 l

Order no. 320001



## Technical data

[Webcode G5406](#)

Total volume [l]	Volume [l]	Height [mm]	Ø max. [mm]	Weight [kg]
<b>Herkules – Septic tank (three chambers)</b>				
	1,600	1600	1350	60
4,800	1,600	1600	1350	60
	1,600	1600	1350	60
<b>Herkules – Septic tank (two chambers)</b>				
	1,600	1600	1350	60
3,200	1,600	1600	1350	60
	1,600	1600	1350	60
<b>Herkules – Septic tank (one chamber)</b>				
1,600	1,600	1600	1350	60
<b>Herkules – Cesspool</b>				
1,600	1,600	1600	1350	60

## Accessories

### Tank dome DN 200

With telescopic end, length 1 m

Order no. 322026

### Extension set

2 x seal DN 100 without connection pipe

Order no. 202028

### Drill DN 100

With view shaft

Order no. 202003

## Unbeatable advantages:



### Long-lasting

Durably sealed thanks to solid profile sealing (seal lifetime of more than 25 years proven in laboratory tests)



### Can be extended as desired

Shape-matched end connectors and connection surfaces enable volumes of several 10,000 l



### Easy transport

Thanks to low weight of 30 kg per half-shell and practical size; fits through all doorways (up to 80 cm)



### Stackable

# Infiltration Tunnel

PERFECT ACCESSORIES FOR  
WASTEWATER TANKS AND  
WASTEWATER SYSTEMS



Presenting the Infiltration Tunnel

GRAF TV  
[www.graf-water.com/graf-tv](http://www.graf-water.com/graf-tv)

The Graf Infiltration Tunnel has been mainly designed for the use in private and rural areas. The system, which consists of one or more tunnel modules and two end plates, can be extended as desired. The tunnel is laid in one or more lines of the same level. As the weight of one module is only 11 kg, the handling of the Infiltration Tunnel is excellent. The surface above the tunnels is suitable for vehicle loading, offering varied possibilities for use.

## Up to 12,000 litres infiltration volume per pallet

Thanks to its special design, the GRAF Infiltration Tunnel can be stacked easily. Consequently, the shipment of up to 40 Infiltration Tunnels on one pallet saves considerable transport and storage costs.

## Vehicle loading

For versatility, the surface above the infiltration tunnels can withstand a continuous load of up to 100 kN/m<sup>2</sup> and is therefore also suitable for vehicle loading.

## Easy installation

The GRAF Infiltration Tunnels are laid in lines and can be flexibly adapted to specific conditions and to the individual storage volume requested. The installation of the modules is easy, quick and variable. Installation is possible without heavy equipment, as one Infiltration Tunnel weighs just 11 kg. The tunnel modules are simply joined together in a line and two end plates are fitted per line.





Flexible connection options  
DN 100/200

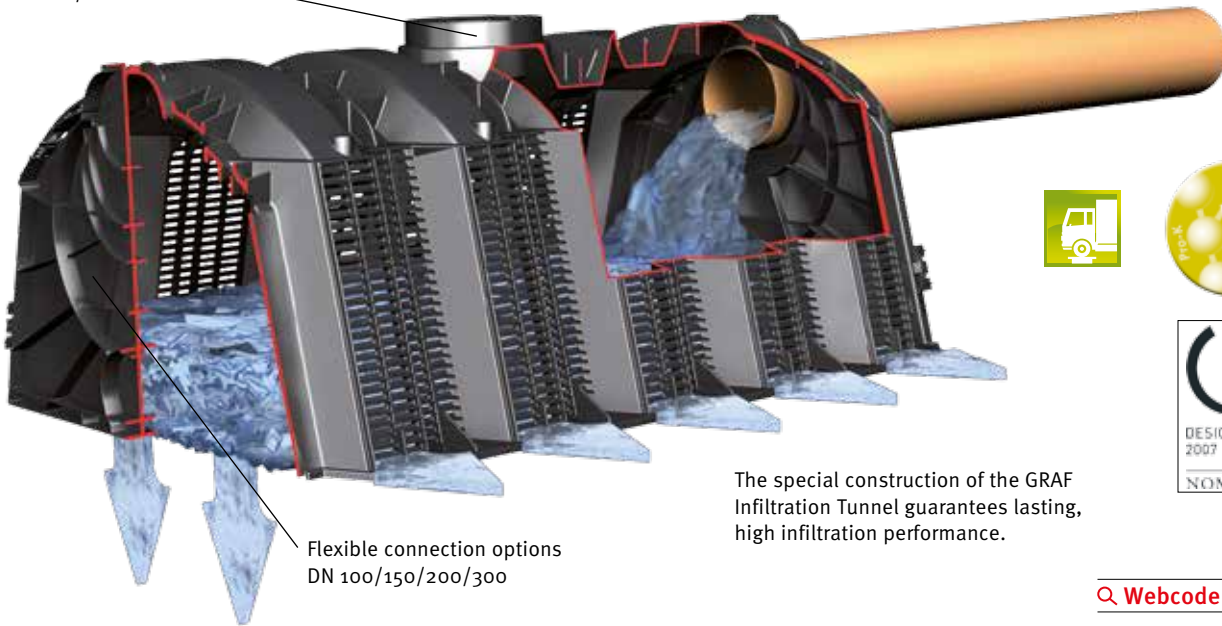

The special construction of the GRAF Infiltration Tunnel guarantees lasting, high infiltration performance.

[Webcode G4103](#)

### Infiltration Tunnel lorry



Volume [l]	Length [mm]	Width [mm]	Height [mm]	Colour	Order no.
300	1160	800	510	black	230010

### End plate for Infiltration Tunnel / Twin



Item	Length [mm]	Colour	Order no.
End plates (Set of 2 units)	30	black	231004

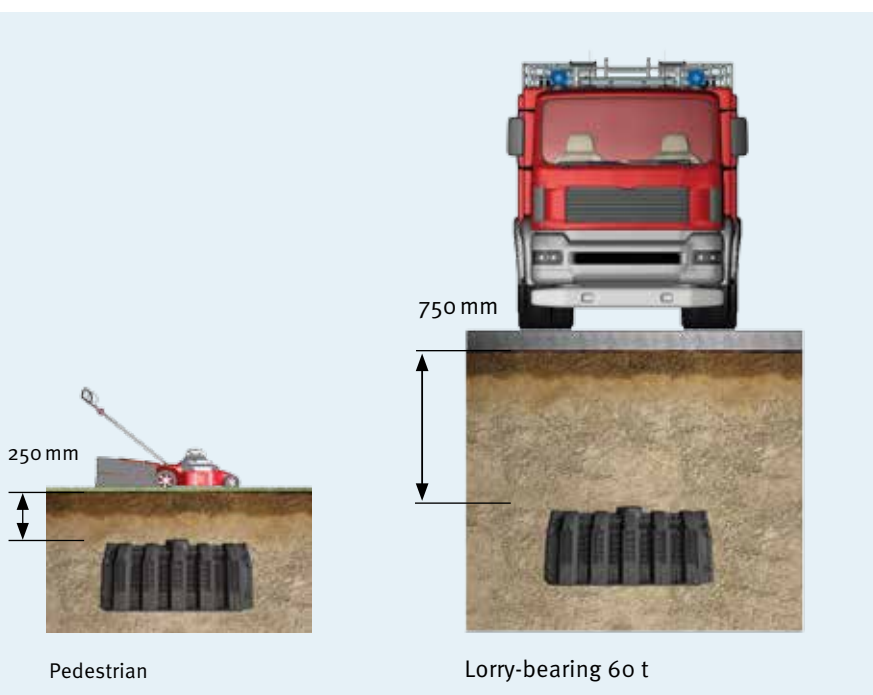

Pedestrian

Lorry-bearing 60 t



### Inspection end

DN 200

Order no. 340527



### Deaeration end

DN 100

Order no. 369017



### GRAF-Tex geotextile

For an Infiltration Tunnel size of 2.50 x 2.50 m

Order no. 231006

### Roll width 5 m

Order no. 231002

# The modular system Carat S

Simply unique

## Carat S underground tank

The Carat S underground tank is the basis for the modular system. It is available in sizes from 2,700 to 6,500 litres and in combined sizes of up to 13,000 litres. Its high quality makes it suitable for vehicle loading and installation in groundwater ([» page 52](#)).

## Tank cover

Would you like to install your tank in the garden or in a yard entrance with traffic? GRAF offers you a wide range of telescopic tank covers from plastic to cast iron ([» page 56](#)).



## System Packs

There are three different types of system packs available. The system pack consists of a control unit (internal or external cabinet) and a set-up kit, which is assembled inside the Carat S tank. ([» page 59](#)).

## Baffle

The baffle separates the Carat S underground tank into two or three chambers as desired. This means that wastewater treatment systems with multiple chambers can be accommodated in just one tank. A Carat S underground tank with baffle is ready for use as a multi-chamber tank ([» page 58](#)).

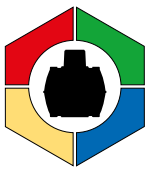

# Choose your system

from four different modules



**Carat S tank**



**Carat S 2,700 litres**  
Order no. 372024

**Carat S 3,750 litres**  
Order no. 372025

**Carat S 4,800 litres**  
Order no. 372026

**Carat S 6,500 litres**  
Order no. 372027



**Tank cover**



**Mini telescopic dome shaft**  
Order no. 371010



**Maxi telescopic tank dome**  
Order no. 371011



**Telescopic dome shaft (lorry-bearing)**  
Order no. 371021



**Telescopic tank dome cast iron**  
Order no. 371020



**Extension**  
Order no. 371003



**Baffles**



**Baffle 2,700 litres position 1/2:**  
Order no. 375067



**Baffle 2,700 litres position 1/3:**  
Order no. 375077



**Baffle 3,750 litres position 1/2:**  
Order no. 375025



**Baffle 3,750 litres position 1/3:**  
Order no. 375080



**Baffle 4,800 litres several positions:**  
Order no. 375026



**Baffle 6,500 litres several positions:**  
Order no. 375027

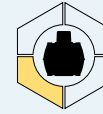

**System packs**



**Klaro E Professional (Klaro L)**



**One2clean**



**Moving bed**

page 52

page 56

page 58

page 59

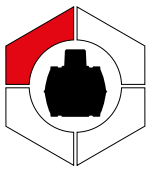

# Carat S underground tank – Benefits

- ✓ Investment security thanks to 15-year warranty – compare it!
- ✓ Very high stability thanks to modern production methods
- ✓ Unique fit accuracy of the components
- ✓ Consistent quality through production monitoring
- ✓ Suitable for vehicle loading (when combined with the cast iron telescopic tank dome)
- ✓ Groundwater-stable up to the middle of the tank thanks to its extremely stable construction
- ✓ Easy to transport due to low weight and encircling H profile
- ✓ Can be expanded as required

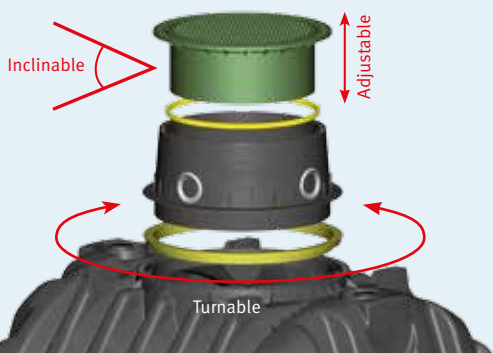
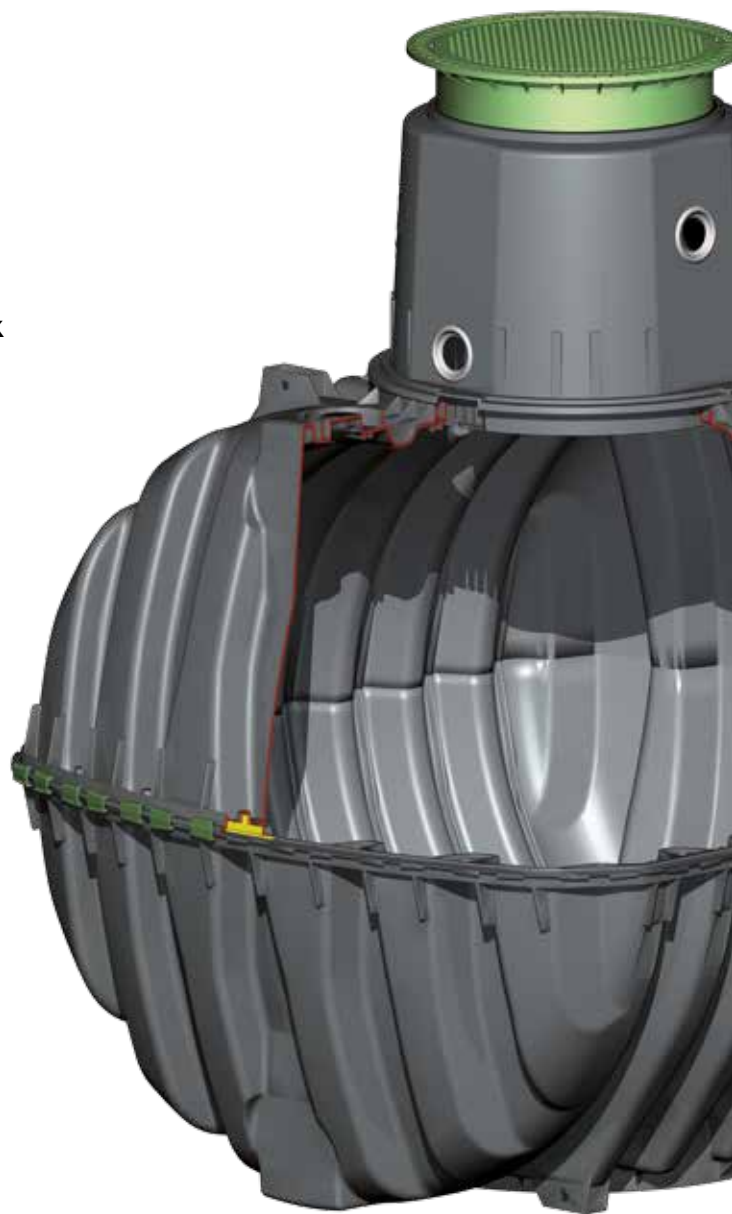

## Flush with ground level

- Numerous seals to effectively stop dirt getting into the tank
- Seals are fitted in the intersection between the tank and tank dome and between the tank dome and telescopic tank dome
- The height of the telescopic tank dome can be smoothly adjusted
- The telescopic tank dome can additionally be inclined by 5° to suit the local conditions
- The production tolerances
- Are kept to a minimum, resulting in unrivalled fitting accuracy

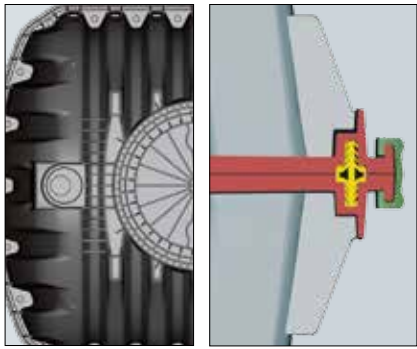

### Extremely stable thanks to the numerous ribs

- ✓ Ribbed tank base
- ✓ Unlike other underground tanks, the wall thickness can be precisely defined and is equal in all areas of the tank
- ✓ Impact-resistant
- ✓ Encircling stabilisation ring in unique H
- ✓ Unique profile for more stability and security



### Logistical advantages of the Carat S

- ✓ Consists of two stackable half-shells
- ✓ Multiple tanks can be stacked on a single pallet for shipping
- ✓ The tank's unique stacking feature directly reduces transport costs and environmental impact from vehicle emissions, whilst allowing shipment to any destination in the world



### Easy and safe assembly

- ✓ Quick connection (shown in green) allows the Carat S tank to be assembled without screws in only a few minutes
- ✓ The top-quality EPDM material used in the profile seals (shown in yellow) has been laboratory-tested
- ✓ The centring bolt (shown in orange) ensures the accurate and easy assembly of the two half-shells, preventing any leaks

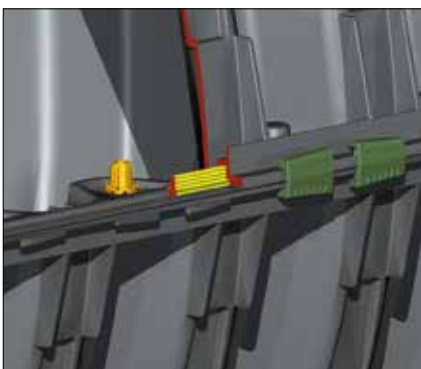

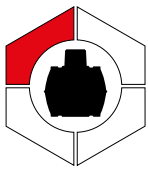

# Carat S underground tank – Logistical Advantages



## Benefits

- Easy to transport
- Tank consisting of two half-shells
- 5 – 9 tanks per pallet
- This allows up to 8 times more tank volume to be shipped thanks to the unique product design
- Up to 36 complete wastewater systems or 45 wastewater tanks per lorry



Carat S: Reduce freight costs by up to 80%

GRAF TV  
[www.graf-water.com/graf-tv](http://www.graf-water.com/graf-tv)



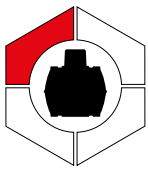

# The modular system Carat S

Choose your tank size



## Carat S underground tank Suitable for vehicle loading

Size 2,700 – 6,500 litres. Designed to be used in conjunction with the vehicle loading telescopic tank dome. The access dome is designed in accordance with DIN testing.



Tank dome Maxi  
Order no. 371040



Tank dome Mini  
Order no. 371041



Tank dome Micro  
Order no. 371009



Illustration shows 4,800 litre tank with telescopic dome shaft for pedestrian loading

[Webcode G5302](#)

### Dimensions

Volume [l]	Width b [mm]	Length l [mm]	Height h [mm]	Height h <sub>tot</sub> [mm]	Height of tank dome ht [mm]	Inner Ø of tank dome [mm]	Weight [kg]	Order no.
2,700 (700 US gal.)	1565 (61.6")	2080 (81.9")	1400 (55.1")	2010 (79.1")	610 (24.0")	650 – 800 (25.6 – 31.5")	120 (265 lbs.)	372024
3,750 (1,000 US gal.)	1755 (69.1")	2280 (89.8")	1590 (62.6")	2200 (86.6")	610 (24.0")	650 – 800 (25.6 – 31.5")	150 (331 lbs.)	372025
4,800 (1,250 US gal.)	1985 (78.2")	2280 (89.8")	1820 (71.6")	2430 (95.7")	610 (24.0")	650 – 800 (25.6 – 31.5")	185 (408 lbs.)	372026
6,500 (1,700 US gal.)	2190 (86.2")	2390 (94.1")	2100 (82.7")	2710 (106.7")	610 (24.0")	650 – 800 (25.6 – 31.5")	220 (485 lbs.)	372027

### Technical data

Max. earth covering (without groundwater vehicle loading)	1200 mm (47.2")
Max. vehicle weight	Suitable for vehicle loading (3.5 t) Higher loads on request
Earth covering required for vehicle loading	800 – 1200 mm (31.5 – 47.2")
Groundwater stability	up to middle of tank
Earth covering required for groundwater stability	800 – 1000 mm (31.5 – 39.4")
Connection	DN 100 / DN 150 / DN 200 on top

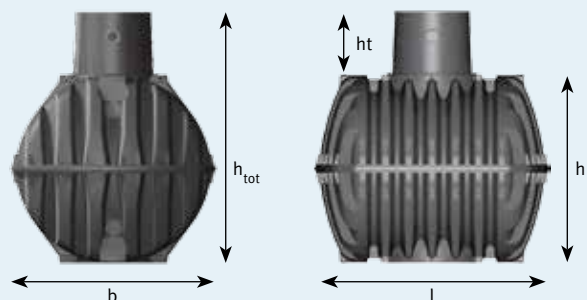

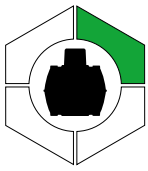

# Tank Domes and Covers

Select your desired tank cover



## Tank dome Mini

- Weight: 11 kg
- For especially flat installation
- incl. 3 edge seals

Order no. 371041



## Tank dome Maxi

- Weight: 15 kg
- For large earth coverings (loading capacity)
- incl. 5 edge seals

Order no. 371040



## Tank dome Micro

- Weight: 7 kg
- including green lid
- for shallow excavation
- earth cover only 90mm

Order no. 371009



## Extension for shafts and domes

- Weight: 6 kg
- The earth covering can be raised 300 mm using the spacer

Order no. 371003

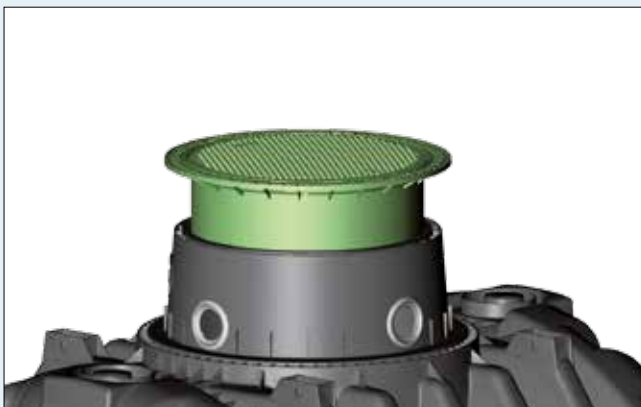

Tank dome Mini



Tank dome Maxi





### Telescopic dome shaft Mini

- with PE cover
- suitable for pedestrian loading
- Weight: 9 kg
- Adjustable earth covering across upper tank surface



plus 140 mm – 340 mm earth covering

Order no. 371010



### Telescopic dome shaft cast iron

- Suitable for vehicle loading – with childproof cast iron cover up to 3.5 t
- Weight: 55 kg
- Adjustable earth covering across upper tank surface



plus 140 mm – 440 mm earth covering

Order no. 371020



### Telescopic dome shaft Maxi

- with PE cover
- suitable for pedestrian loading
- Weight: 15 kg
- Adjustable earth covering across upper tank surface



plus 140 mm – 440 mm earth covering

Order no. 371011



### Telescopic dome shaft \*

- Suitable for vehicle/ loading
- Weight: 11 kg
- Cover to be provided on site
- Adjustable earth covering across upper tank surface
- For commercially available concrete rings/covers (to be provided on site)



plus 140 mm – 440 mm earth covering

Order no. 371021

\*on request



Telescopic dome shaft suitable for pedestrian loading



Telescopic dome shaft suitable for vehicle/ loading



# The modular system Carat S

Choose your baffle position

The baffle separates the Carat S underground tank into two or three chambers as desired. It consists of two halves and is simple to insert when assembling the second tank half of the Carat S.

A profile seal provides reliable and permanent separation of the chambers. The Carat S underground tank with baffle is ready for use as a multi-chamber tank. This can then be expanded by means of a system pack to create a wastewater treatment system (» page 59). The system pack is simply fitted to the baffle and the control unit is installed in the house – and the wastewater treatment system is ready to go.

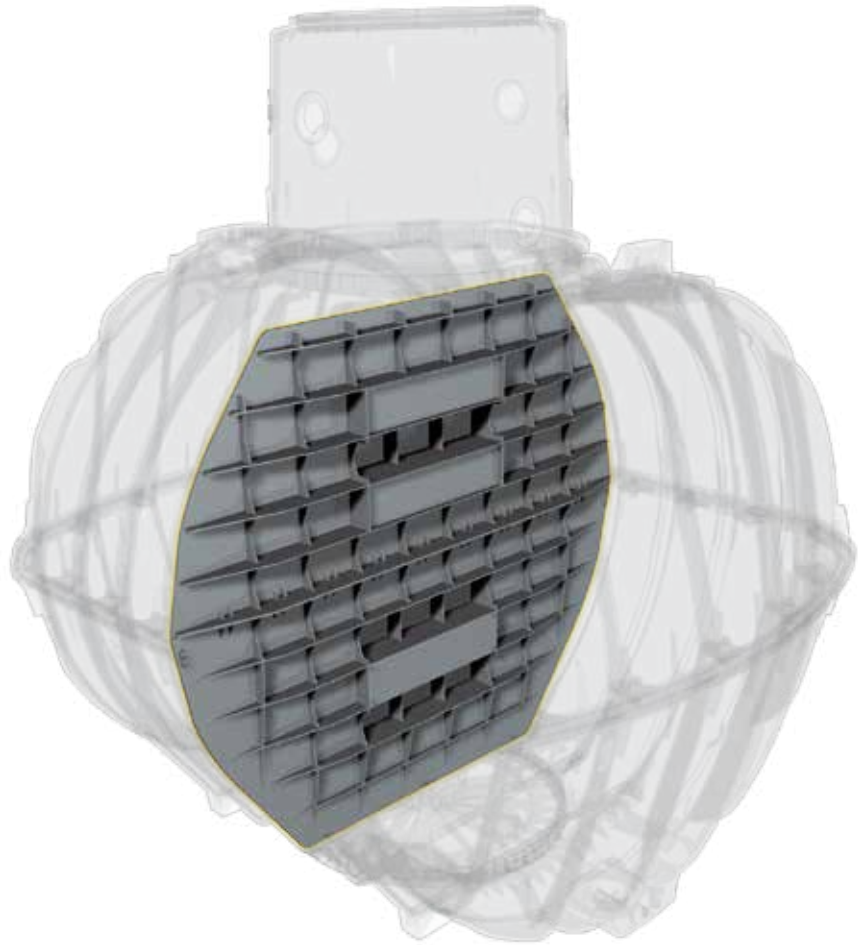
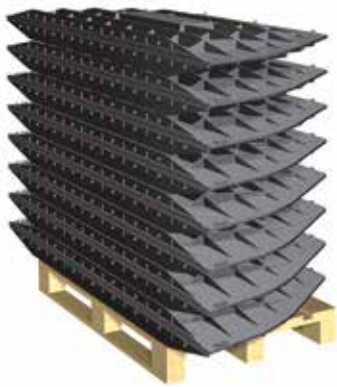

## Baffle for Carat S tank

Volume [l]	pcs/pal	Positions	Weight [kg]	Order no.
2,700	9	1/2	20	375067
2,700	9	1/3	20	375077
3,750	7	1/2	25	375025
3,750	7	1/3	25	375080
4,800	5	several positions	35	375026
6,500	5	several positions	45	375027



The baffles of the Carat S underground tank are supplied on pallets and can easily be inserted in the tanks as needed.

## Flexible baffle positions

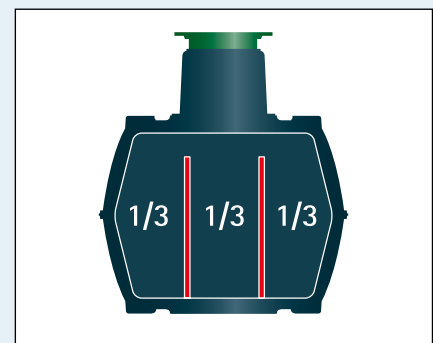
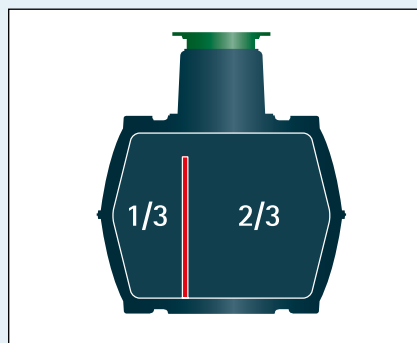
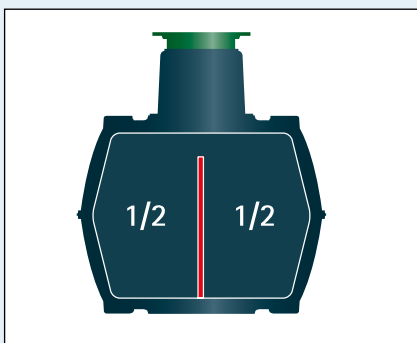

Examples of different baffle positions.

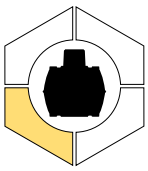

# The modular system Carat S

Choose your system pack



## System pack Klaro E Professional



The system pack Klaro E Professional (▶ page 12) works according to the SBR air lift pump process. This requires a wastewater tank with two chambers. Scope of supply: control cabinet with air compressor for internal mounting, Klaro E Professional system pack comprising air lift pumps and disk diffuser. Air hose not included.

### SBR hose package

(1 x Ø 19 mm; 3 x Ø 13 mm)

5 m	Order no. 107189
10 m	Order no. 107190
15 m	Order no. 107191
20 m	Order no. 107192

### Sizes

Inhabitants [max.]	Volume [l]	System packs [Order no.]	
<b>For one-tank systems</b>			
		Set-up kits	Internal control cabinet
5	2,700	107437	107445
8	3,750	107438	107447
10	4,800	107439	107449
14	6,500	107440	107457

Inhabitants [max.]	Volume [l]	System packs [Order no.]	
<b>For multitank systems</b>			
		Set-up kits	Internal control cabinet
10	2 x 2,700	107495	107457
16	2 x 3,750	107496	107705
22	2 x 4,800	107497	107705
28	2 x 6,500	107498	107705
32	4 x 3,750	107797	107471
44	4 x 4,800	107798	107471
50	4 x 6,500	107799	107472

Inhabitants [max.]	Volume [l]	System packs [Order no.]	
<b>For Klaro L</b>			
60	4 x 6,500	372710	
90	5 x 6,500	372711	
120	7 x 6,500	372712	
150	9 x 6,500	372713	
180	10 x 6,500	372714	

## System pack one2clean



The system pack one2clean (▶ page 24) works according to the SBR air lift pump process. This requires a wastewater tank with a Saum baffle. Scope of supply: control cabinet with air compressor for internal mounting, one2clean system pack comprising air lift pumps and tube diffuser. Air hose not included.

Inhabitants [max.]	Volume [l]	System packs [Order no.]	
<b>For one-tank systems</b>			
3	2,700	106850	
5	3,750	106851	
7	4,800	106852	
9	6,500	106853	

Inhabitants [max.]	Volume [l]	System packs [Order no.]	
<b>For two-tank systems</b>			
7	2 x 2,700	106854	
10	2 x 3,750	106855	
14	2 x 4,800	106856	
18	2 x 6,500	106857	

## System pack Moving bed



The moving bed system pack (▶ page 33) works according to the moving bed process. This requires a wastewater tank with three chambers. Scope of supply: control cabinet with analogue control and air compressor, carrier material, ventilator, sludge removal and all connecting links. Air hose not included.

### Sizes

Inhabitants [max.]	Volume [l]	System packs [Order no.]	
20	2 x 3,750   2 x 2,700	372727	
28	2 x 4,800   2 x 3,750	372728	
36	2 x 6,500   2 x 3,750	372729	
44	2 x 6,500   2 x 3,750	372730	
50	3 x 4,800   2 x 4,800	372731	
70	3 x 4,800   2 x 6,500	372721	
90	3 x 6,500   5 x 4,800	372722	
120	9 x 6,500	372723	
140	9 x 6,500	372724	
160	11 x 6,500	372725	
200	12 x 6,500	372726	

# Carat XL underground tank

8,500 and 10,000 litres



## Carat XL underground tank Suitable for vehicle / 12 t

- Suitable for loading up to 12 t
- Can be mounted in groundwater
- Lower weight than concrete and steel
- Various connection surfaces  
DN 100/150 /200
- Investment security thanks to a 15-year warranty

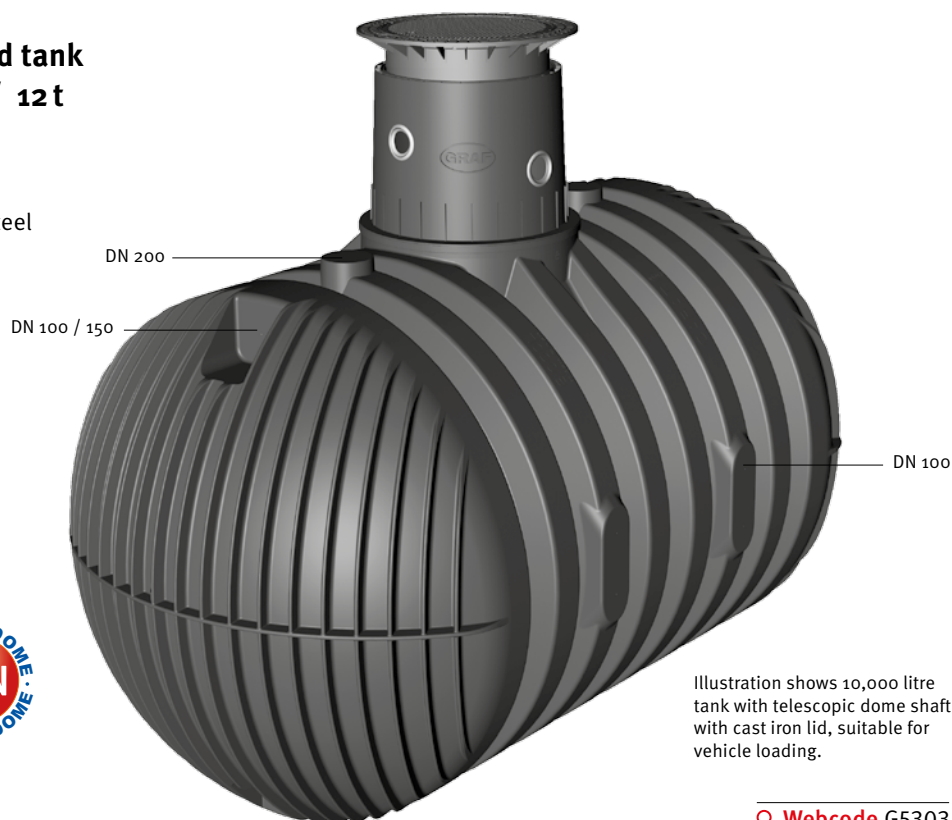

Illustration shows 10,000 litre tank with telescopic dome shaft with cast iron lid, suitable for vehicle loading.

[Webcode G5303](#)

## Dimensions

Volume [l]	Width b [mm]	Length l [mm]	Height h [mm]	Height h <sub>tot</sub> [mm]	Height of dome shaft h <sub>t</sub> [mm]	Internal Ø of dome shaft [mm]	Weight [kg]	Order no.
8,500	2040	3500	2085	2695	610	650	380	370005
10,000	2240	3520	2285	2895	610	650	456	370006

## Technical data

Max. earth covering (without groundwater vehicle loading)	1500 mm
Max. axle load	8 t
Max. total weight	12 t
Earth covering required for vehicle loading	800 mm – 1200 mm
Groundwater stability	up to middle of tank
Earth covering required for groundwater stability	800 mm – 1200 mm
Connection	DN 100 / DN 150 / DN 200 on top

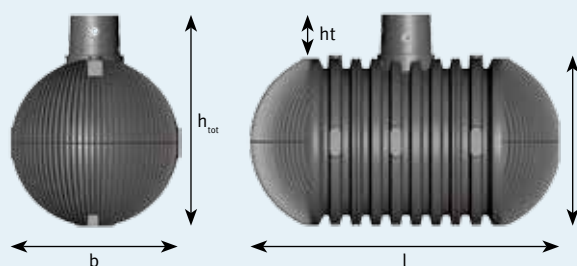

# Carat XXL underground tank

up to 76,000 litres



## Carat XXL underground tank Suitable for vehicle / 40 t

- Suitable for loading up to 40 t
- Can be mounted in groundwater
- Lower weight than concrete and steel
- Various connection surfaces  
DN 100/150 /200
- Available with DN 300 connection as an option
- Available with a second tank dome as an option
- 76,000 litre volume possible
- Investment security thanks to a 15-year warranty

DN 300  
connection on  
end face on  
request

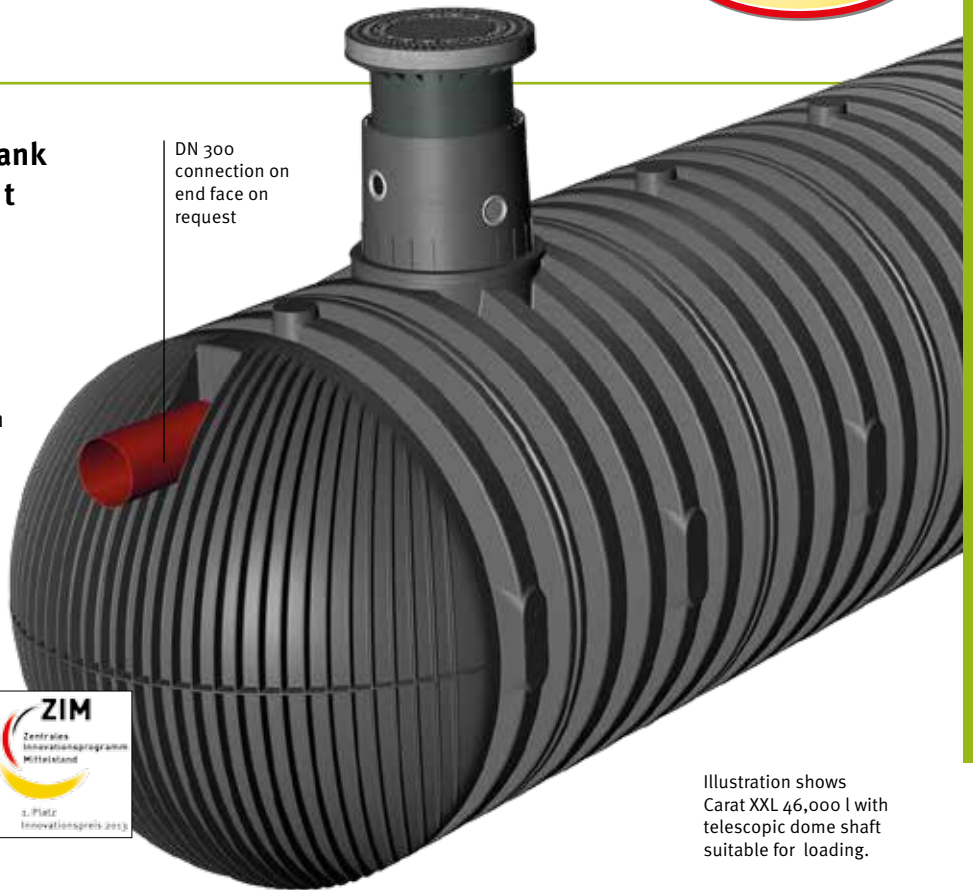

Illustration shows  
Carat XXL 46,000 l with  
telescopic dome shaft  
suitable for loading.

**Webcode** G5304

## Dimensions

Volume [l]	Width W [mm]	Length l [mm]	Height h [mm]	Height h <sub>tot</sub> [mm]	Height of dome shaft ht [mm]	Internal Ø of dome shaft [mm]	Weight [kg]	Order no.
16,000	2500	4660	2550	3160	610	650	805	380001
22,000*	2500	6145	2550	3160	610	650	1015	380000
26,000	2500	7045	2550	3160	610	650	1150	380002
32,000*	2500	8530	2550	3160	610	650	1360	380003
36,000	2500	9430	2550	3160	610	650	1495	380004
42,000*	2500	10915	2550	3160	610	650	1705	380005
46,000	2500	11815	2550	3160	610	650	1840	380006
52,000*	2500	13 300	2550	3160	610	650	2050	380007
56,000	2500	14 200	2550	3160	610	650	2185	380008
62,000*	2500	15685	2550	3160	610	650	2395	380009
66,000	2500	16585	2550	3160	610	650	2530	380010
72,000*	2500	18 070	2550	3160	610	650	2740	380011
76,000	2500	18 970	2550	3160	610	650	2875	380012

Up to 102,000 litres on request

\*with a second tank dome

## Technical data

Max. axle load:	8 t
Max. total weight:	3.5 t with cast iron cover, 40 t with -bearing telescopic dome shaft
Earth covering with loading capacity:	800 mm – 1500 mm
Groundwater stability:	up to the middle of the tank
Earth covering with groundwater installation:	800 mm – 1500 mm
Connection:	DN 100 – DN 200

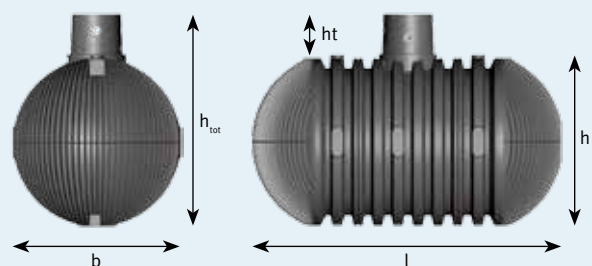



## Advantages

- ✓ Easy to transport (standard 20 ft container)
- ✓ Prefabricated, expandable design
- ✓ Rapid assembly and disassembly
- ✓ Low power consumption (1.2 kWh per 1,000 l water treated)
- ✓ Designed for 10,000 l per day (more on request)
- ✓ Parallel connection for larger volumes of wastewater



### container.blue

20 ft container; up to 10,000 l/d

Order no. 160000



## container.blue systems are suitable for

- ✓ Working camps
- ✓ Mining camps
- ✓ Military camps
- ✓ Quarries
- ✓ Logging camps
- ✓ Temporary works
- ✓ Research camps

## Technical data

### General system data

- Equipment: 20 ft side door container
- Material: Steel
- Weight (tare): 3180 kg
- Dimensions: (L) 6058 mm; (B) 2114 mm; (H) 2169 mm
- Inlet: DN 110; height 2310 mm
- Outlet: DN 110; height 415 mm
- Ventilation: DN 110; height 2310 mm
- Operating voltage: 400 V, 50 Hz (60 Hz)
- Rated current: 32 A
- Temperature range: -10°C...+35°C
- Power consumption: 10-12 kWh/d

### Wastewater treatment data

- Inflow volume: 10 m<sup>3</sup>/d more on request
- BOD<sub>5</sub> load: 4 kg/d (60 gBOD<sub>5</sub>/inhab.\*d)
- Operating time: 24 h
- Operation: Automatic

### Process quality

- pH: 7 – 8
- FS: < 30 mg/l
- BOD<sub>5</sub>: < 10 mg/l
- COD: < 20 mg/l
- NH<sub>4</sub>-N: < 10 mg/l
- Ntot: < 20 mg/l



PIA, independent testing institute in Aachen



## General specifications

- Container: 20 ft, side & rear door opening for easy access
- Plug & play, ready for immediate use
- Ideal for changing locations
- Fully automated purification process
- Excellent cleaning performance, even in winter
- Also ideal for fluctuating waste water flow rates
- Virtually odourless thanks to vented tanks
- Access from side and front, not from above
- Low energy requirements, low operating costs
- No electrical, mechanical, or sensor systems in the waste water, so particularly sturdy and durable
- All pumps driven by compressed air
- Can be expanded as desired



### Control cabinet

- Air-conditioned
- Microprocessor controlled
- Solenoid valves
- Piston compressors



### Container

- 20 ft
- Includes four wastewater tanks with a total volume of 16,000 litres
- Accessable from the side an front



### Reference

- An Australian mining company uses a container.blue system to clean wastewater from workers' accommodation.



## Designed for easy operation

Container Wastewater Systems are engineered and constructed in Germany with maximum operating reliability our priority. container.blue Systems are installed in many countries in a range of operating conditions in industries like mining and tourism as well as remote villages.

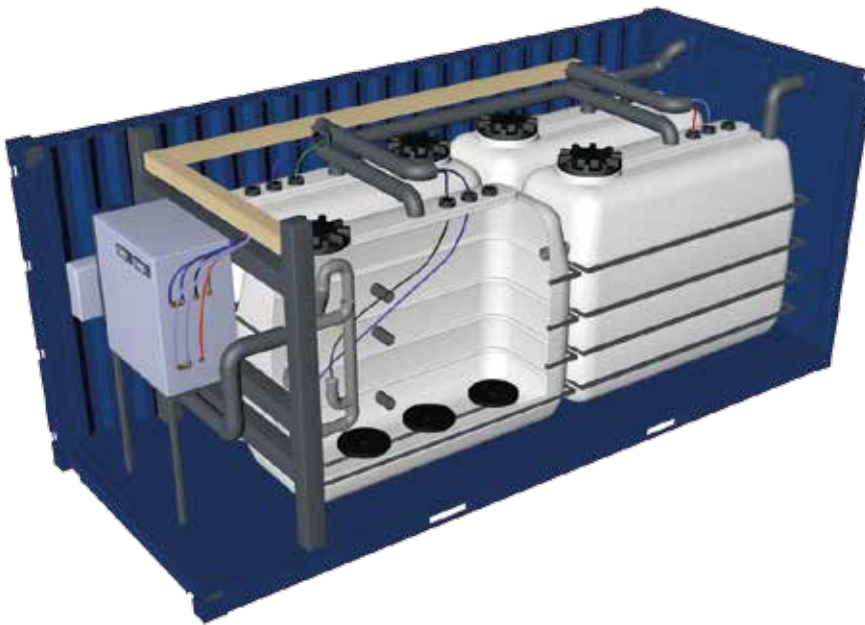

- ✓ 20' containers for ease of transport
- ✓ Designed to treat up to 10,000 l per day
- ✓ Treats all sewage wastewater
- ✓ Disinfection options – UV & chlorine
- ✓ Reliable SBR / 2-stage aerobic process
- ✓ Less maintenance knowledge needed
- ✓ Full training & manuals supplied



## Cleaning performance

The cleaning performance was established in a practical field test lasting several weeks. The system was gradually filled with untreated domestic wastewater. In this case, the maximum filling quantity amounted to 10 m<sup>3</sup> per day.

The notified testing institute for wastewater technology (PIA GmbH) determined the cleaning performance at the test location by taking samples of the inflow and outflow.

## Options

**+D +P +C +H +R**

» page 21

# Separator

---



In operations where wastewater containing, this wastewater must be treated separately using a separator before being discharged to the sewer system. A recipitation system works according to the phase separation principle. It consists of a precipitation area, a grease collector, a sludge trap and a sampling

point. The system reduces the flow rate of the wastewater to allow solids – such as food leftovers – to sink and settle in the sludge trap. Fats, which have a lower density than water, float to the surface. Once the grease is removed, the wastewater is flowing to the sewer system.

The choice of nominal size for the separator is specified in EN 1825. The wastewater requirements of the relevant authority must be complied with (e.g. 14-day emptying; monthly emptying with the approval of the relevant authority).

✓ **A integrated sampling point is possible**

✓ **Minimum maintenance costs**

✓ **The dome shaft can be telescoped and shortened in a continuously variable manner**



### Dimensions Saphir

NS [l/s]	ø DN [mm]	ø Tank body [mm]	Height [mm]	Weight [kg]
1 (0.26 US gal./s)	100 (4")	1130 (3' 9")	1480–1680 (4' 10"–5' 6")	35 (77 lbs.)
2 (0.52 US gal./s)	100 (4")	1130 (3' 9")	1480–1680 (4' 10"–5' 6")	35 (77 lbs.)
2 (0.52 US gal./s)	100 (4")	1160 (3' 10")	1780–1980 (5' 10"–6' 6")	55 (121 lbs.)
2 (0.52 US gal./s)	100 (4")	1160 (3' 10")	1780–1980 (5' 10"–6' 6")	55 (121 lbs.)
2 (0.52 US gal./s)	100 (4")	1160 (3' 10")	2110–2310 (6' 11"–7' 7")	67 (148 lbs.)
4 (1.05 US gal./s)	100 (4")	1160 (3' 10")	2110–2310 (6' 11"–7' 7")	67 (148 lbs.)

### Tank volume

Grease [l]	Sludge [l]	Total [l]
200 (52 US gal)	200 (52 US gal)	490 (129 US gal)
200 (52 US gal)	200 (52 US gal)	490 (129 US gal)
400 (105 US gal)	200 (52 US gal)	770 (203 US gal)
200 (52 US gal)	400 (105 US gal)	770 (203 US gal)
300 (79 US gal)	500 (132 US gal)	1,070 (283 US gal)
300 (79 US gal)	500 (132 US gal)	1,070 (283 US gal)



### Dimensions Diamant

NS [l/s]	ø DN [mm]	Length [mm]	Width [mm]	Height [mm]	Weight [kg]
4 (1.05 US gal./s)	150 (6")	2450 (8')	1150 (3' 9")	1760–2150 (5' 9"–7' 1")	155 (341 lbs.)
7 (1.85 US gal./s)	150 (6")	2450 (8')	1150 (3' 9")	1760–2150 (5' 9"–7' 1")	155 (341 lbs.)
10 (2.64 US gal./s)	200 (8")	2450 (8')	1400 (4' 7")	2010–2400 (6' 7"–7' 11")	235 (518 lbs.)
15 (3.96 US gal./s)	200 (8")	2450 (8')	1400 (4' 7")	2010–2400 (6' 7"–7' 11")	235 (518 lbs.)

### Tank volume

Grease [l]	Sludge [l]	Total [l]
350 (92 US gal)	700 (185 US gal)	2,070 (546 US gal)
350 (92 US gal)	700 (185 US gal)	2,070 (546 US gal)
600 (158 US gal)	1,500 (396 US gal)	3,160 (835 US gal)
600 (158 US gal)	1,500 (396 US gal)	3,160 (835 US gal)

# sepa.compact

Light fluid separator

## Separator systems for light fluid liquids class I + II

Separators are needed wherever water is contaminated with oils and other light liquids. Separator systems are classified according to NS (NormSize).

When you submit an enquiry for a separator system, we calculate the NS you require based on the maximum possible throughflow. Operators of the following

facilities must ensure that a suitable, functioning separator is installed: Car washes, workshops, fuel stations, vehicle fleets, hazardous goods stores

- ✓ Available as fuel separator (class II) or coalescence separator (class I)
- ✓ Up to NS 10 (20)
- ✓ Upstream sludge trap can be added
- ✓ With integrated sampling point on request



### Dimensions Saphir

NS [l/s]	ø DN [mm]	Length [mm]	Width [mm]	Height [mm]	Weight [kg]
3 (0.79 US gal./s)	150 (6")	116 (4.6")	116 (4.6")	1760 – 2150 (5' 9" – 7' 1")	90 (198 lbs.)

### Tank volume

Oil [l]	Sludge [l]	Total [l]
500 (132 US gal.)	400 (105 US gal.)	1,090 (288 US gal.)

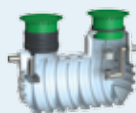

### Dimensions Diamant

NS [l/s]	ø DN [mm]	Length [mm]	Width [mm]	Height [mm]	Weight [kg]
3 (0.79 US gal./s)	150 (6")	2450 (8')	1150 (3' 9")	1760 – 2150 (5' 9" – 7' 1")	185 (408 lbs.)
6 (1.60 US gal./s)	150 (6")	2450 (8')	1150 (3' 9")	1760 – 2150 (5' 9" – 7' 1")	185 (408 lbs.)
10 (2.64 US gal./s)	150 (6")	2450 (8')	1150 (3' 9")	1760 – 2150 (5' 9" – 7' 1")	185 (408 lbs.)

### Tank volume

Oil [l]	Sludge [l]	Total [l]
500 (132 US gal.)	1,500 (396 US gal.)	2,150 (568 US gal.)
500 (132 US gal.)	1,500 (396 US gal.)	2,150 (568 US gal.)
500 (132 US gal.)	1,500 (396 US gal.)	2,150 (568 US gal.)

## Coalescence separator and fuel separator

The sepa.compact+ separator systems are coalescence separators of class I. They feature an additional coalescence unit that enables a much higher degree

of separation. The sepa.compact separator systems are fuel separators of class II. A fuel separator achieves a degree of separation of less than 100 mg residual

oil per litre of water. With a coalescence unit, this can be reduced to less than 5 mg/l.

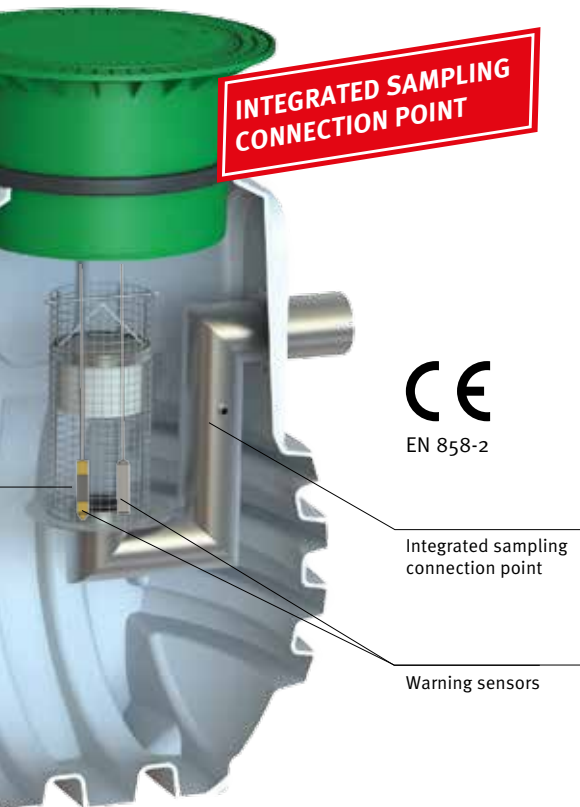
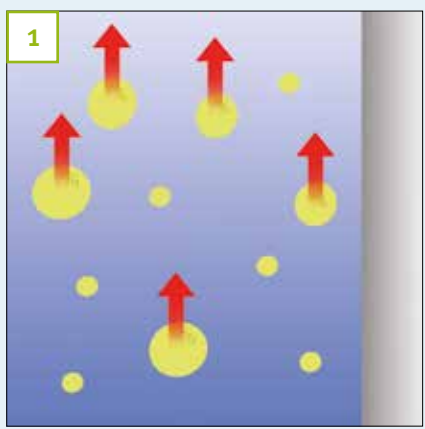
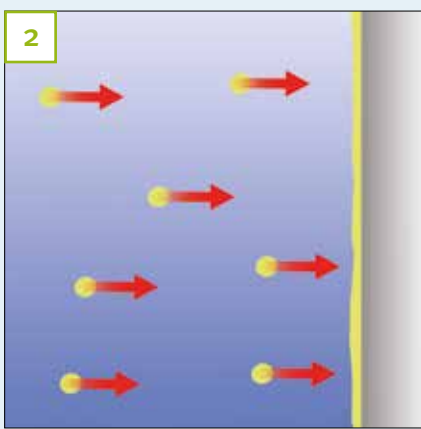

Illustration shows Saphir NS 3 sepa.compact+ with coalescence unit, integrated sampling connection point and warning sensors



In addition to easily separate drops of oil, a light fluid separator also contains very fine oil droplets whose density is not sufficiently different from water for them to rise to the surface in the available time. These droplets therefore remain in the outflowing water.



To separate out these smaller droplets, a coalition material is fitted before the discharge to which the droplets stick and form a oil film.

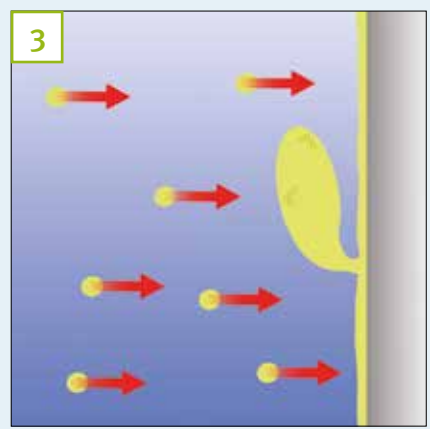

As more oil flows in, the film becomes thicker until it can no longer adhere to the material. Individual drops break off the film, which are large enough to rise to the surface through difference in density and be separated out.



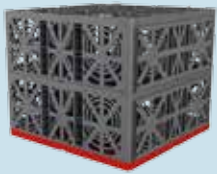

**GRAF EcoBloc  
Inspect flex**



**GRAF EcoBloc  
maxx**



**Vario 800 flex  
shaft system**



**Multi Infiltration shaft  
DN 400 / 600**



**Industrial Universal  
filter 3**



**Carat S retention  
detention**



**Infiltration  
Tunnel**

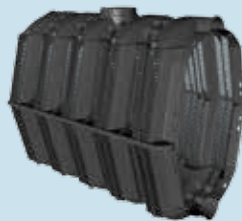

**Infiltration  
Tunnel twin**

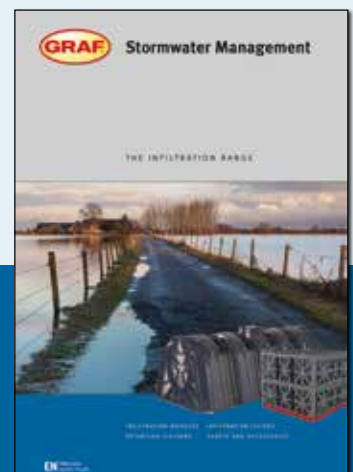

**Stormwater management**  
For more information about our  
stormwater management,  
ask for our catalogue.



## RAINWATER HARVESTING



## INFILTRATION



## WASTEWATER TREATMENT SOLUTIONS



## MULTIPURPOSE CONTAINERS



Your expert specialist dealer:

### Rainwater Harvesting Solutions

For more information about our Rainwater Harvesting Solutions, ask for our catalogue.



#### Prices:

A price list with our export conditions is available on request.

#### Warranty clause:

The warranty mentioned in this brochure only refers to the tank in question and not to the accessories. Within the warranty period we grant free replacement of the material. Further benefits are excluded. Pre-condition for warranty benefits are proper handling, assembly and installation according to the mounting guidelines.

N.B. Protect tanks from frost when installed above ground! In case of groundwater installation, please contact us for further information prior to purchase!

For all indications of measurements in this brochure we reserve a tolerance of +/- 3%. The usage volume of the tanks may be up to 10% lower than the tank Volume, depending on the connecting option.

Technical modifications and further development of the various products are subject to change. Errors excepted.

For all our offers and conclusions of contract, only our General Terms and Conditions of Business dated 01/10/2012 shall apply, which we will send to you on request.

Otto Graf GmbH  
Kunststoffzeugnisse  
Carl-Zeiss-Straße 2-6  
DE-79331 Teningen

Phone: +49 7641 589-0  
Fax: +49 7641 589-50  
mail@graf.info  
www.graf-water.com

Graf UK Ltd  
Target House  
Thorpe Way Industrial Estate  
Banbury

Oxfordshire  
OX16 4SP  
Phone: +44 1608 661-500  
info@grafuk.co.uk  
www.grafuk.co.uk

© Otto Graf GmbH, Teningen, Germany  
Reproduction – also in extracts –  
only with written authorisation  
Item no. 960286/EN